



Catalogue
Cum Price List
w.e.f. : Oct. 01, 2022

Modular Switches,
Board Mounting Switches,
MCB's, MCB's Db's,
Switchgears, spares and Wires

The Company

We are oldest switch-makers of India since 1935. An era where producing a high grade electrical switch was inconceivable, our founder Late Shri Shanti Swarup Khosla manufactured the superlative tumbler switches and electrical accessories , with the vision to bring light to the homes of India. The vision was further enhanced by his son, Late Shri Krishan Swarup Khosla who brought a major turnaround in the company with his creativity and exceptional organisation skills, he originated high tech modular and luxury switches and myriad of electrical commodities. This legacy of excellence and expansion is further carried forward by our Managing Director Shri Nitin Khosla who emphasises on maintaining a long lasting relationship with the clients through quality perfection. SSK has revolutionised the electrical engineering industry with its unwavering quest for bringing state of the art products and technology to the nation.





01) LICA DX SERIES 02 - 07



02) LICA SERIES 03 - 17



03) ZEN-2 18 - 23



04) METAL 24 - 29



05) CROWN MARK -2 AND CROWN 30 - 41



06) SIGNATURE-EL 42 - 46

07) TECHNICAL PERFORMANCE OF SSK MODULAR SWITCHES

47



08) SIGNATURE-NV 48 - 51



09) ACE 52 - 55



10) GRAND 56 - 59



11) ILLUMINATING BELL PUSH 60



12) METAL CASE BELL PUSH 61



13) TOUCH 62 - 65



14) TOPLINE / DIMPLE 66 - 69



15) FANTASY 70 - 73



16) HOLDERS, ACCESSORIES 74 - 79



17) WIRES & CABLES 80 - 81



18) MCB DISTRIBUTION BOARDS 82 - 84



19) PHASE SELECTORS 85



20) MCB's 86 - 87



21) AUTOMATIC CHANGEOVER SWITCHES 88 - 91



22) BUSBAR CHAMBERS 92 - 93



23) SWITCH FUSE UNITS, FUSE SWITCH UNITS 94 - 95



24) CHANGEOVER SWITCHES & PORCELAIN FUSE UNITS 96 - 97



25) AC BOXES, PLUG SOCKETS 97



26) SPARES 98 - 101



27) HERITAGE SWITCHES (LUXURY RANGE) 102



28) ROYAL SWITCHES (LUXURY RANGE) 103



Lica
 DX

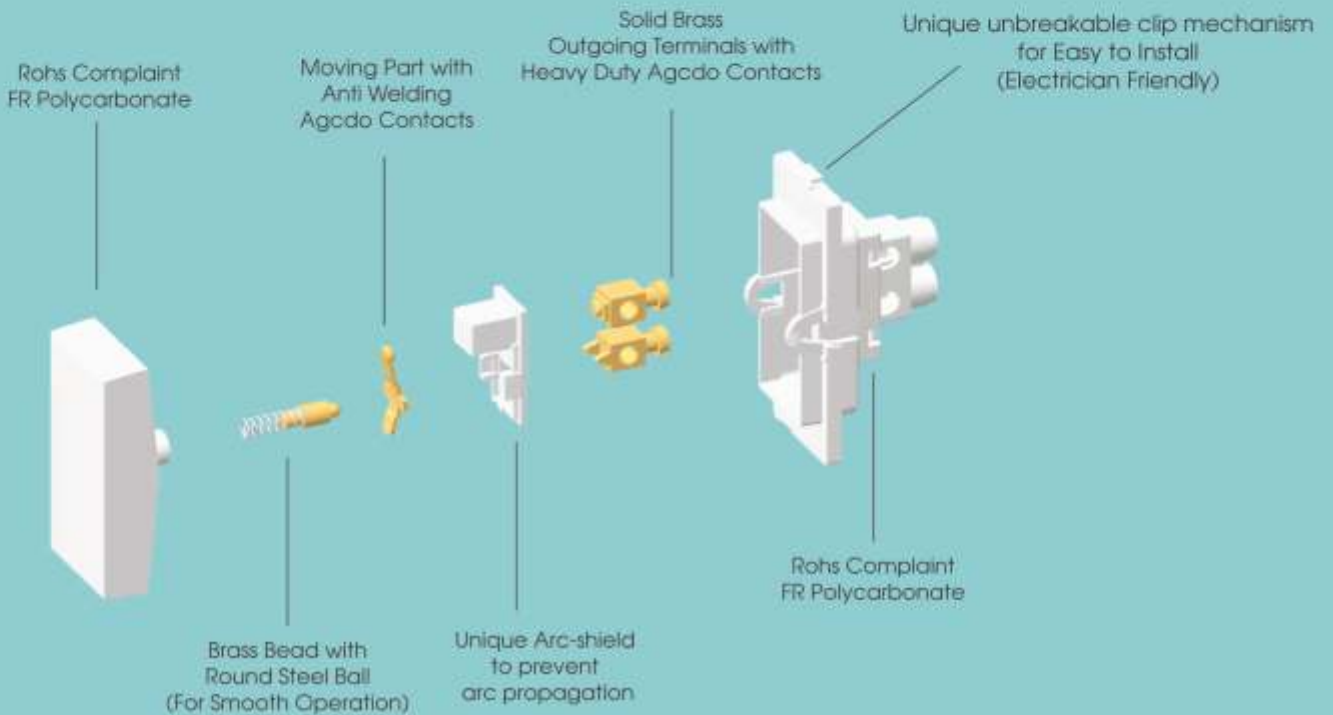

Easy to Install

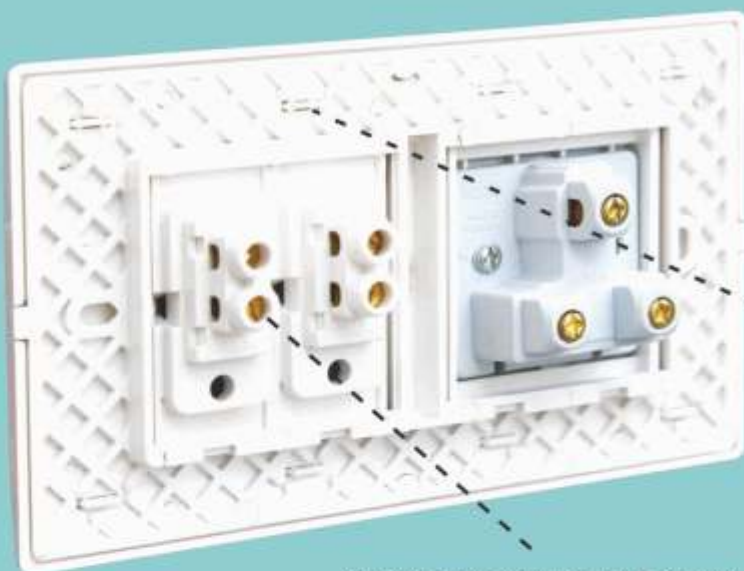

Convenient brass terminals screws
anti skid

Unique smooth locking clips



Performance of SSK LICA DX switches tested at our lab :-

- ▲ It withstood 3KV (rms) for 2 minutes.
- ▲ It did not increase 14°C after 50,000 operations in 10AX accessories and 18°C after 50,000 operations in 16 amp accessories.
- ▲ Not exceeded 7mv after 1,20,000 ON-OFF operations in 6 amp and 9mv in 16 amp.
(After this endurance test the products were found in good working conditions).
- ▲ Found more than 500M ohms (after humidity treatment).
- ▲ We tested our switches at 1,20,000 operations on load. (Even after this test, switches worked properly).
- ▲ Tested at a maximum impact energy 1Nm for all rating and designs. (Hammer stoke test from a distance of 270mm).
- ▲ Switches and sockets were tested at 130% of all rated current and 110% of the rated voltage for 1500 operations and were found to be in good working conditions thereafter.
- ▲ There was no sign of any impression on the body (insulation material) of our products, after heating at 125°C for 100 minutes.
- ▲ Was not effected by abnormal heat and fire at 850°C.

*Perfectly designed
for your imagination*



DX



Lica
DX

PRODUCTS



LDX-100 LDX-101 LDX-102



LDX-206 LDX-206A



LDX-102A LDX-207 LDX-208



LDX-209 LDX-210 LDX-211



LDX-212 LDX-213 LDX-213A



LDX-214 LDX-215



LDX-216 LDX-217

Cat. No.	DESCRIPTION	LIST PRICE/Pc.	HSN CODE	BOX/PCS.	Carton Pkg.
LDX-100	One way switch 10AX 250V AC ISI	114.00	8536	20 PCS.	400 Pcs.
LDX-101	Two way switch 10AX 250V AC ISI	171.00	8536	20 PCS.	-----
LDX-102	Bell push 10AX 250V AC ISI	178.00	8536	20 PCS.	-----
LDX-206	One way switch 20AX 250V AC ISI	183.00	8536	20 PCS.	-----
LDX-206A	One way switch 20AX 250V AC ISI with indicator	244.00	8536	20 PCS.	-----
LDX-102A	Mega bell push 10AX 250V AC ISI	187.00	8536	10 PCS.	-----
LDX-207	Mega one way switch 20AX 250V AC ISI	189.00	8536	10 PCS.	-----
LDX-208	Mega two way switch 20AX 250V AC ISI	203.00	8536	10 PCS.	-----
LDX-209	Mega single pole switch one way 32AX 250V AC ISI	404.00	8536	10 PCS.	-----
LDX-210	Mega double pole switch one way 32AX 250V AC ISI	479.00	8536	10 PCS.	-----
LDX-211	Mega double pole switch one way 32AX 250V AC ISI with indicator	517.00	8536	10 PCS.	-----
LDX-212	Neon Indicator	166.00	8531	20 PCS.	-----
LDX-213	Dimmer 500W ac for light switch size	616.00	8414	10 PCS.	-----
LDX-213A	Fan regulator 0-4 steps switch size 100W hum free	599.00	8414	10 PCS.	-----
LDX-214	Fan regulator 0-5 steps socket size 100W hum free	709.00	8414	05 PCS.	-----
LDX-215	Dimmer 500W AC for light socket size	667.00	8414	05 PCS.	-----
LDX-216	Dimmer 700W AC for light socket size	860.00	8414	05 PCS.	-----
LDX-217	2 pin socket 6A 250V AC	113.00	8536	20 PCS.	-----

PRODUCTS

Cat. No. DESCRIPTION LIST PRICE/Pc. HSN CODE BOX/PCS. Carton Pkg.



LDX-219 LDX-219B LDX-219A

LDX-219 5 pin socket 6A 250V AC shuttered 180.00 8536 10 PCS. 140 PCS.

LDX-219B 5 pin socket 6A 250V AC W/o Shutter 180.00 8536 10 PCS. 140 PCS.

LDX-219A Universal socket 6A-13A 250V AC 275.00 8536 10 PCS. 140 PCS.



LDX-220 LDX-220A LDX-1067

LDX-220 6 pin socket 6A-16A 250V AC shuttered 348.00 8536 10 PCS. 110 PCS.

LDX-220A 6 pin socket 6A-25A 250V AC shuttered 373.00 8536 10 PCS. 110 PCS.

LDX-1067 Modular mcb 32A DP 'C' series 1021.00 8536 10 PCS. ---



LDX-224 LDX-226 LDX-227 LDX-228

LDX-224 Single telephone line jack 2 wire 197.00 8517 20 PCS. ---

LDX-226 T.V. socket single outlet 184.00 8529 20 PCS. ---

LDX-227 Blanking plate one module 37.00 8538 20 PCS. ---

LDX-228 Mega blanking plate 61.00 8538 10 PCS. ---



LDX-229D LDX-234 LDX-246

LDX-229D Computer jack RJ 45 for data transfer switch size cat.6 1409.00 8536 10 PCS. ---

LDX-234 Single phase motor starter 25A 602.00 8536 05 PCS. ---

LDX-246 Usb charging port 2 Amp. 916.00 8536 10 PCS. ---



LDX-241 LDX-242 LDX-1066

LDX-241 Modular mcb 16A SP 'C' series 486.00 8536 10 PCS. ---

LDX-242 Modular mcb 25A SP 'C' series 486.00 8536 10 PCS. ---

LDX-1066 Modular mcb 32A SP 'C' series 617.00 8536 10 PCS. ---



LDX-555 LDX-777

LDX-555 Energy Saver Foot Light 4"x3" 910.00 8531 05 PCS. ---

LDX-777 Electronic energy saver foot light with 5"x3" cover plate 1390.00 8531 05 PCS. ---



LDX-243 LDX-244

LDX-243 Modular mcb 16A SP 'C' series with 6 pin 16A socket fitted with 4"x3" frame 1855.00 8536 05 PCS. ---

LDX-244 Modular mcb 25A SP 'C' series with 6 pin 25A socket fitted with 4"x3" frame 2186.00 8536 05 PCS. ---

COVER WITH BASE PLATES (In Polycarbonate)

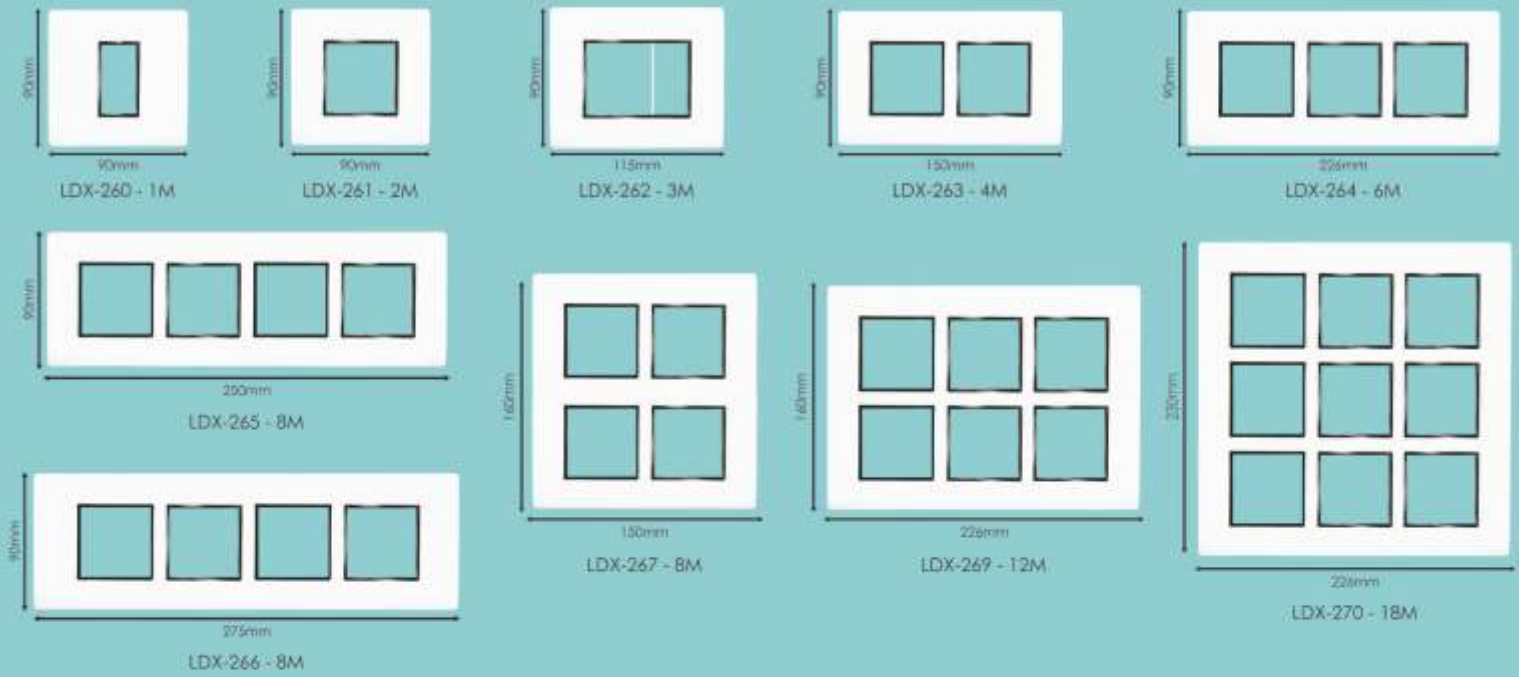

CAT. NO.	FRAMES	HSN CODE	BOX PACKING / PCS.	LIST PRICE/Pc.
LDX-260	1M FRAME WITH BASE 3" X 3"	8538	10 PCS.	149.00
LDX-261	2M FRAME WITH BASE 3" X 3"	8538	10 PCS.	150.00
LDX-262	3M FRAME WITH BASE 4" X 3"	8538	10 PCS.	189.00
LDX-263	4M FRAME WITH BASE 5" X 3"	8538	10 PCS.	233.00
LDX-264	6M FRAME WITH BASE 8" X 3"	8538	10 PCS.	315.00
LDX-265	8M FRAME WITH BASE 9" X 3"	8538	10 PCS.	337.00
LDX-266	8M FRAME WITH BASE 10" X 3"	8538	10 PCS.	398.00
LDX-267	8M FRAME WITH BASE 5" X 5"	8538	10 PCS.	398.00
LDX-269	12M FRAME WITH BASE 8" X 6"	8538	05 PCS.	500.00
LDX-270	18M FRAME WITH BASE 8" X 8"	8538	05 PCS.	679.00

BASE PLATES FITTING DIMENSIONS

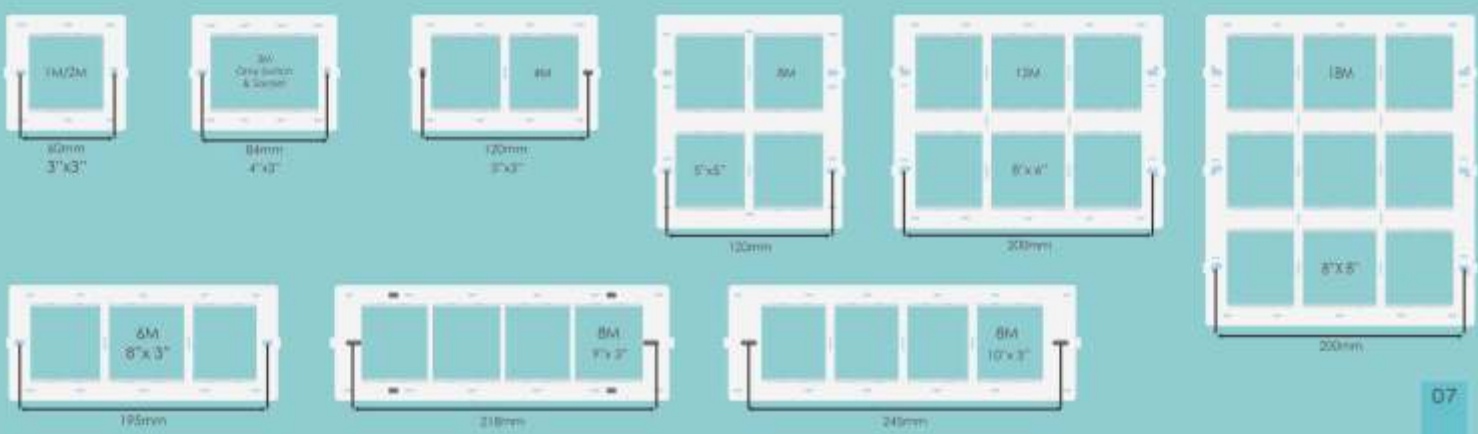

An ultimate combination
of design and luxury.



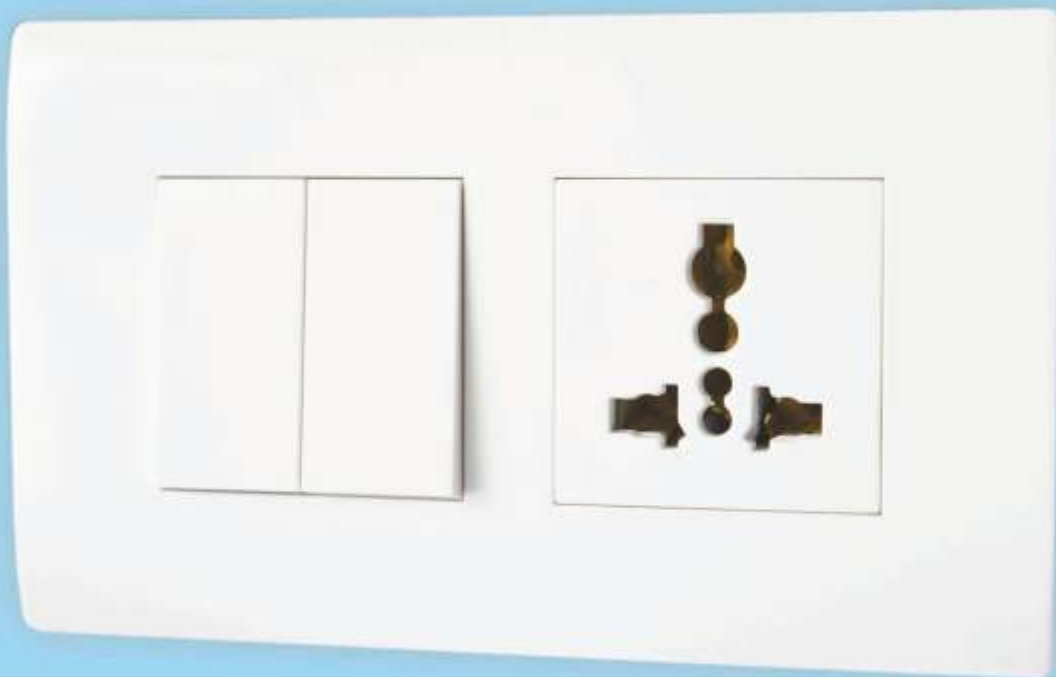

More stylish
More functional
More aesthetic
Lica collection is perfect for adding
an elegant touch to your space.

Create a timeless and trendy aesthetic throughout your home with stunning finish of Lica Collection.



New



Energy Saver Foot Light

Lica

PRODUCTS



LC-100 LC-101 LC-102



LC-206 LC-206A



LC-102A LC-207 LC-208



LC-209 LC-210 LC-211



LC-212 LC-213 LC-213A



LC-214 LC-215



LC-216 LC-217

Cat. No.	DESCRIPTION	LIST PRICE/Pc.	HSN CODE	BOX/PCS.	Carton Pkg.
LC-100	One way switch 10AX 250V AC ISI	114.00	8536	20 PCS.	400 Pcs.
LC-101	Two way switch 10AX 250V AC ISI	171.00	8536	20 PCS.	----
LC-102	Bell push 10AX 250V AC ISI	178.00	8536	20 PCS.	----
LC-206	One way switch 20AX 250V AC ISI	183.00	8536	20 PCS.	----
LC-206A	One way switch 20AX 250V AC ISI with indicator	244.00	8536	20 PCS.	----
LC-102A	Mega bell push 10AX 250V AC ISI	187.00	8536	10 PCS.	----
LC-207	Mega one way switch 20AX 250V AC ISI	189.00	8536	10 PCS.	----
LC-208	Mega two way switch 20AX 250V AC ISI	203.00	8536	10 PCS.	----
LC-209	Mega single pole switch one way 32AX 250V AC ISI	404.00	8536	10 PCS.	----
LC-210	Mega double pole switch one way 32AX 250V AC ISI	479.00	8536	10 PCS.	----
LC-211	Mega double pole switch one way 32AX 250V AC ISI with indicator	517.00	8536	10 PCS.	----
LC-212	Neon Indicator	166.00	8531	20 PCS.	----
LC-213	Dimmer 500W ac for light switch size	616.00	8414	10 PCS.	----
LC-213A	Fan regulator 0-4 steps switch size 100W hum free	599.00	8414	10 PCS.	----
LC-214	Fan regulator 0-5 steps socket size 100W hum free	709.00	8414	05 PCS.	----
LC-215	Dimmer 500W AC for light socket size	667.00	8414	05 PCS.	----
LC-216	Dimmer 700W AC for light socket size	860.00	8414	05 PCS.	----
LC-217	2 pin socket 6A 250V AC	113.00	8536	20 PCS.	----

PRODUCTS

Cat. No. DESCRIPTION LIST PRICE/Pc. HSN CODE BOX/PCS. Carton Pkg.



LC-219 LC-219B LC-219A



LC-220 LC-220A LC-1067



LC-224 LC-226 LC-227 LC-228



LC-229D LC-234 LC-246



LC-241 LC-242 LC-1066



LC-555 LC-777



LC-243 LC-244

LC-219	5 pin socket 6A 250V AC shuttered	180.00	8536	10 PCS.	140 PCS.
LC-219B	5 pin socket 6A 250V AC w/o Shutter	180.00	8536	10 PCS.	140 PCS.
LC-219A	Universal socket 6A-13A 250V AC	275.00	8536	10 PCS.	140 PCS.

LC-220	6 pin socket 6A-16A 250V AC shuttered	348.00	8536	10 PCS.	110 PCS.
LC-220A	6 pin socket 6A-25A 250V AC shuttered	373.00	8536	10 PCS.	110 PCS.
LC-1067	Modular mcb 32A DP 'C' series	1021.00	8536	10 PCS.	---

LC-224	Single telephone line jack 2 wire	197.00	8517	20 PCS.	---
LC-226	T.V. socket single outlet	184.00	8529	20 PCS.	---
LC-227	Blanking plate one module	37.00	8538	20 PCS.	---
LC-228	Mega blanking plate	61.00	8538	10 PCS.	---

LC-229D	Computer jack RJ 45 for data transfer switch size cat.6	1409.00	8536	10 PCS.	---
LC-234	Single phase motor starter 25A	602.00	8536	05 PCS.	---
LC-246	Usb charging port 2 Amp.	916.00	8536	10 PCS.	---

LC-241	Modular mcb 16A SP 'C' series	486.00	8536	10 PCS.	---
LC-242	Modular mcb 25A SP 'C' series	486.00	8536	10 PCS.	---
LC-1066	Modular mcb 32A SP 'C' series	617.00	8536	10 PCS.	---

LC-555	Energy Saver Foot Light 4"x3"	910.00	8531	05 PCS.	---
LC-777	Electronic energy saver foot light with 5"x3" cover plate	1390.00	8531	05 PCS.	---

LC-243	Modular mcb 16A SP 'C' series with 6 pin 16A socket fitted with 4"x3" frame	1855.00	8536	05 PCS.	---
LC-244	Modular mcb 25A SP 'C' series with 6 pin 25A socket fitted with 4"x3" frame	2186.00	8536	05 PCS.	---

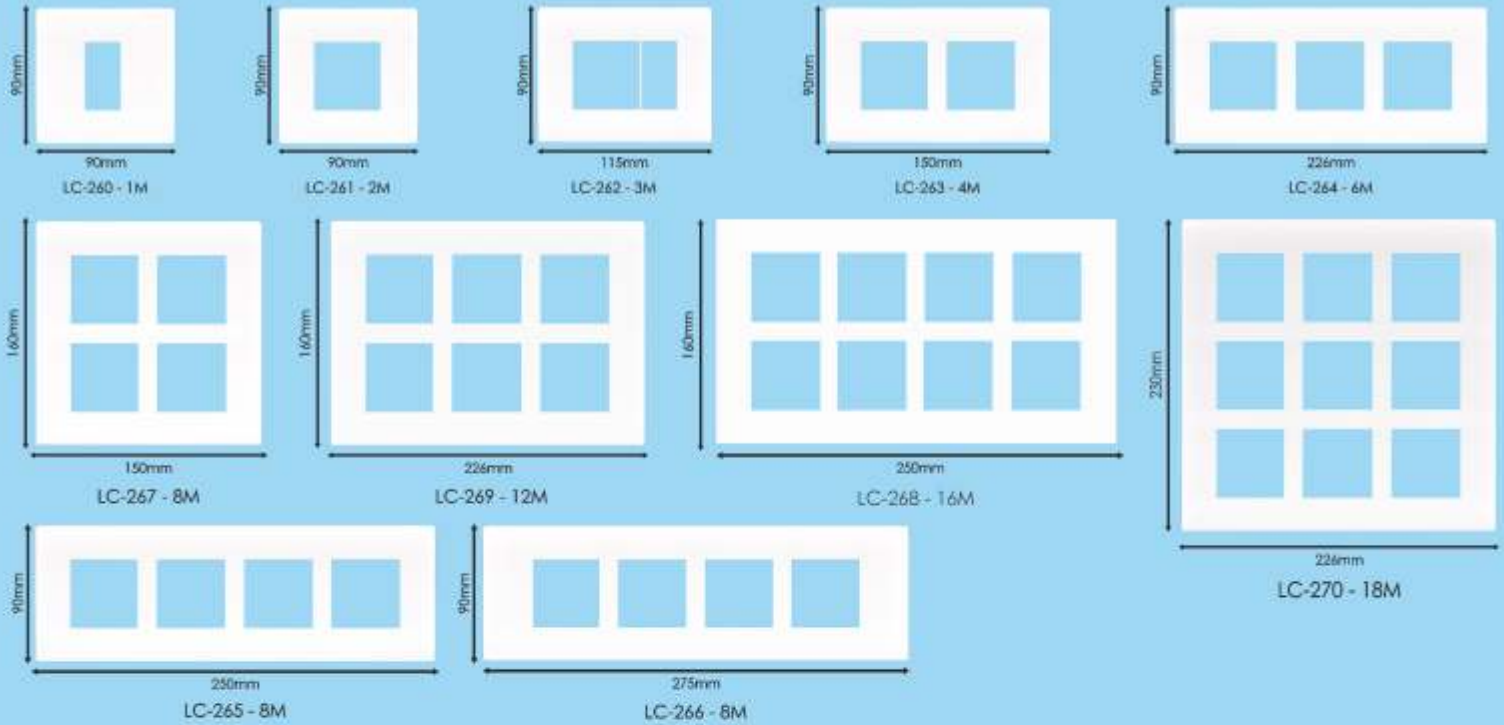

CAT. NO.	FRAMES	HSN CODE	BOX PACKING / PCS.	LIST PRICE/Pc.
LC-260	1M FRAME WITH BASE 3" X 3"	8538	10 PCS.	149.00
LC-261	2M FRAME WITH BASE 3" X 3"	8538	10 PCS.	150.00
LC-262	3M FRAME WITH BASE 4" X 3"	8538	10 PCS.	189.00
LC-263	4M FRAME WITH BASE 5" X 3"	8538	10 PCS.	233.00
LC-264	6M FRAME WITH BASE 8" X 3"	8538	10 PCS.	315.00
LC-265	8M FRAME WITH BASE 9" X 3"	8538	10 PCS.	337.00
LC-266	8M FRAME WITH BASE 10" X 3"	8538	10 PCS.	398.00
LC-267	8M FRAME WITH BASE 5" X 5"	8538	10 PCS.	398.00
LC-268	16M FRAME WITH BASE 9" X 6"	8538	05 PCS.	594.00
LC-269	12M FRAME WITH BASE 8" X 6"	8538	05 PCS.	500.00
LC-270	18M FRAME WITH BASE 8" X 8"	8538	05 PCS.	679.00

BASE PLATES FITTING DIMENSIONS



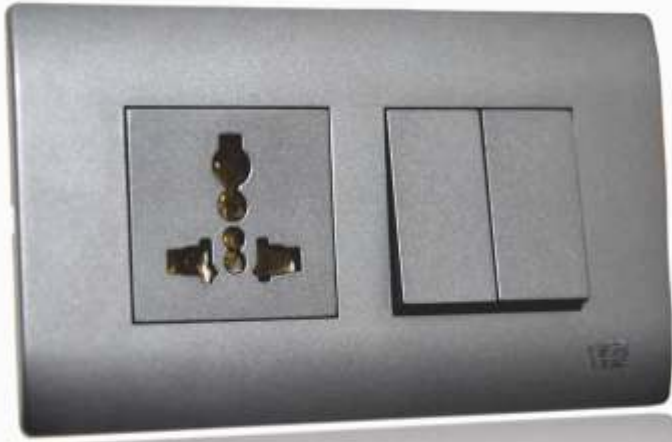

Grey



Matt Black



PRODUCTS

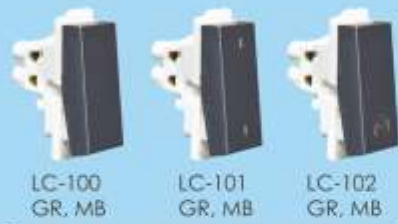

Cat. No.	DESCRIPTION	LIST PRICE/Pc.	HSN CODE	BOX/PCS.	Carton Pkg.
LC-100 GR, MB	One way switch 10AX 250V AC ISI	142.00	8536	20 PCS.	400 Pcs.
LC-101 GR, MB	Two way switch 10AX 250V AC ISI	200.00	8536	20 PCS.	-----
LC-102 GR, MB	Bell push 10AX 250V AC ISI	212.00	8536	20 PCS.	-----
LC-206 GR, MB	One way switch 20AX 250V AC ISI	217.00	8536	20 PCS.	-----
LC-206A GR, MB	One way switch 20AX 250V AC ISI with indicator	286.00	8536	20 PCS.	-----
LC-102A GR, MB	Mega bell push 10AX 250V AC ISI	218.00	8536	10 PCS.	-----
LC-207 GR, MB	Mega one way switch 20AX 250V AC ISI	236.00	8536	10 PCS.	-----
LC-208 GR, MB	Mega two way switch 20AX 250V AC ISI	254.00	8536	10 PCS.	-----
LC-209 GR, MB	Mega single pole switch one way 32AX 250V AC ISI	506.00	8536	10 PCS.	-----
LC-210 GR, MB	Mega double pole switch one way 32AX 250V AC ISI	600.00	8536	10 PCS.	-----
LC-211 GR, MB	Mega double pole switch one way 32AX 250V AC ISI with indicator	646.00	8536	10 PCS.	-----
LC-212 GR, MB	Neon Indicator	194.00	8531	20 PCS.	-----
LC-213 GR, MB	Dimmer 500W ac for light switch size	702.00	8414	10 PCS.	-----
LC-213A GR, MB	Fan regulator 0-4 steps switch size 100W hum free	686.00	8414	10 PCS.	-----
LC-214 GR, MB	Fan regulator 0-5 steps socket size 100W hum free	810.00	8414	05 PCS.	-----
LC-215 GR, MB	Dimmer 500W AC for light socket size	764.00	8414	05 PCS.	-----
LC-216 GR, MB	Dimmer 700W AC for light socket size	993.00	8414	05 PCS.	-----
LC-217 GR, MB	2 pin socket 6A 250V AC	138.00	8536	20 PCS.	-----

PRODUCTS



LC-219
GR, MB

LC-219B
GR, MB

LC-219A
GR, MB



LC-220
GR, MB

LC-220A
GR, MB

LC-224
GR, MB



LC-226
GR, MB

LC-227
GR, MB

LC-228
GR, MB



LC-229D
GR, MB

LC-234
GR, MB

LC-246
GR, MB



LC-241
GR, MB

LC-242
GR, MB

LC-1066
GR, MB

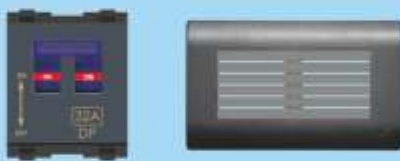

LC-1067
GR, MB

LC-777
GR, MB



LC-243
GR, MB

LC-244
GR, MB

Cat. No.	DESCRIPTION	LIST PRICE/Pc.	HSN CODE	BOX/PCS.	Carton Pkg.
LC-219 GR, MB	5 pin socket 6A 250V AC shuttered	238.00	8536	10 PCS.	140 PCS.
LC-219B GR, MB	5 pin socket 6A 250V AC W/o Shutter	238.00	8536	10 PCS.	140 PCS.
LC-219A GR, MB	Universal socket 6A-13A 250V AC	350.00	8536	10 PCS.	140 PCS.
LC-220 GR, MB	6 pin socket 6A-16A 250V AC shuttered	429.00	8536	10 PCS.	110 PCS.
LC-220A GR, MB	6 pin socket 6A-25A 250V AC shuttered	455.00	8536	10 PCS.	110 PCS.
LC-224 GR, MB	Single telephone line jack 2 wire	221.00	8517	20 PCS.	----
LC-226 GR, MB	T.V. socket single outlet	220.00	8529	20 PCS.	----
LC-227 GR, MB	Blanking plate one module	62.00	8538	20 PCS.	----
LC-228 GR, MB	Mega blanking plate	118.00	8538	10 PCS.	----
LC-229D GR, MB	Computer jack RJ 45 for data transfer switch size cat.6	1565.00	8536	10 PCS.	----
LC-234 GR, MB	Single phase motor starter 25A	688.00	8536	05 PCS.	----
LC-246 GR, MB	Usb charging port 2 Amp.	1014.00	8536	10 PCS.	----
LC-241 GR, MB	Modular mcb 16A SP 'C' series	544.00	8536	10 PCS.	----
LC-242 GR, MB	Modular mcb 25A SP 'C' series	544.00	8536	10 PCS.	----
LC-1066 GR, MB	Modular mcb 32A SP 'C' series	678.00	8536	10 PCS.	----
LC-1067 GR, MB	Modular mcb 32A DP 'C' series	1142.00	8536	10 PCS.	----
LC-777 GR, MB	Electronic energy saver foot light with 5"x3" cover plate	1676.00	8531	05 PCS.	----
LC-243 GR, MB	Modular mcb 16A SP 'C' series with 6 pin 16A socket fitted with 4"x3" frame	2116.00	8536	05 PCS.	----
LC-244 GR, MB	Modular mcb 25A SP 'C' series with 6 pin 25A socket fitted with 4"x3" frame	2492.00	8536	05 PCS.	----

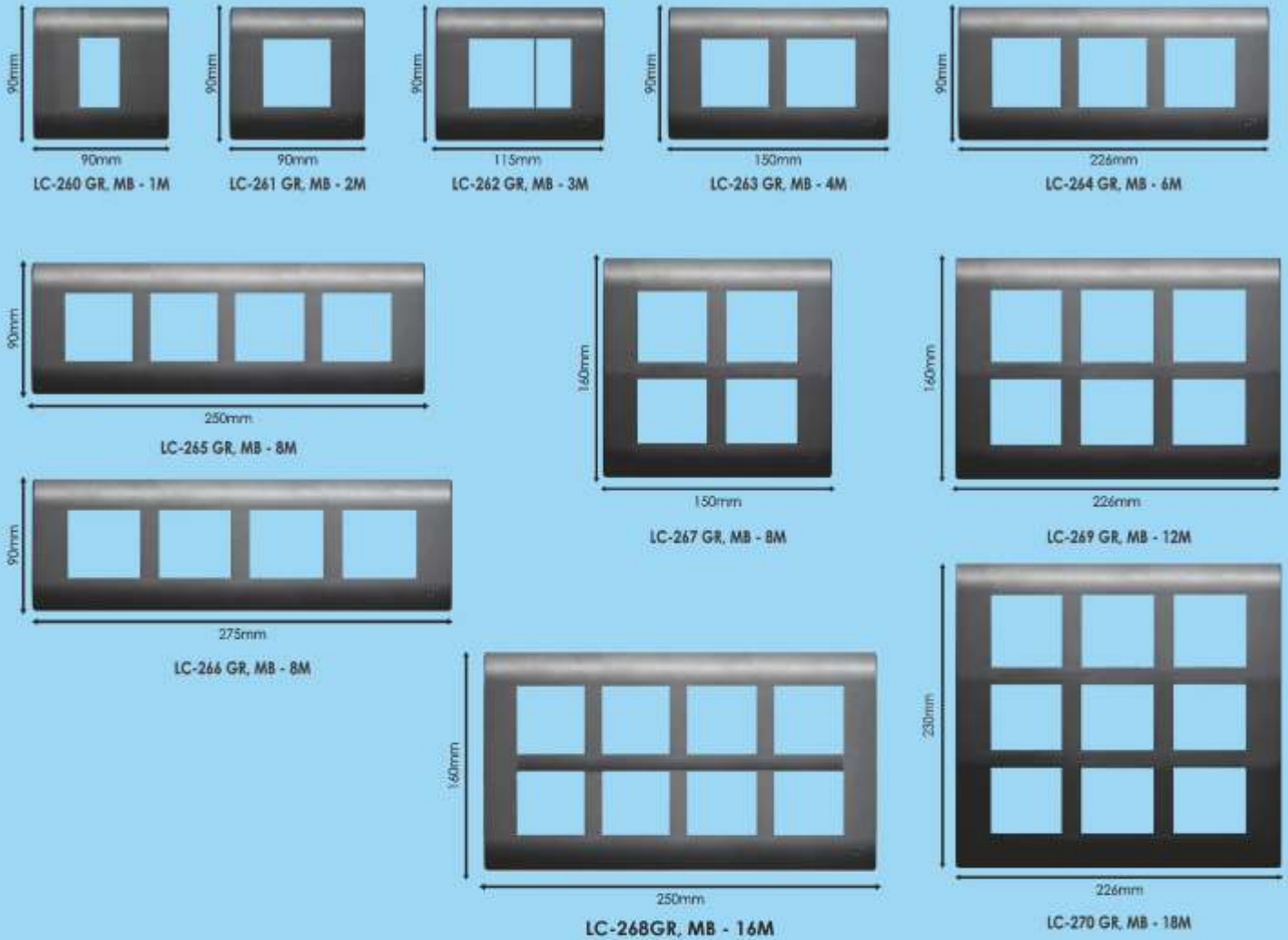

CAT. NO.	FRAMES	HSN CODE	BOX PACKING / PCS.	LIST PRICE/Pc.
LC-260 GR, MB	1M FRAME WITH BASE 3" X 3"	8538	10 PCS.	209.00
LC-261 GR, MB	2M FRAME WITH BASE 3" X 3"	8538	10 PCS.	211.00
LC-262 GR, MB	3M FRAME WITH BASE 4" X 3"	8538	10 PCS.	284.00
LC-263 GR, MB	4M FRAME WITH BASE 5" X 3"	8538	10 PCS.	356.00
LC-264 GR, MB	6M FRAME WITH BASE 8" X 3"	8538	10 PCS.	463.00
LC-265 GR, MB	8M FRAME WITH BASE 9" X 3"	8538	10 PCS.	522.00
LC-266 GR, MB	8M FRAME WITH BASE 10" X 3"	8538	10 PCS.	584.00
LC-267 GR, MB	8M FRAME WITH BASE 5" X 5"	8538	10 PCS.	580.00
LC-268 GR, MB	16M FRAME WITH BASE 9"X6"	8538	05 PCS.	760.00
LC-269 GR, MB	12M FRAME WITH BASE 8" X 6"	8538	05 PCS.	657.00
LC-270 GR, MB	18M FRAME WITH BASE 8" X 8"	8538	05 PCS.	849.00

Please use code {MB for Matt Black} and {GR for Grey} while ordering...



GRAPHITE GREY

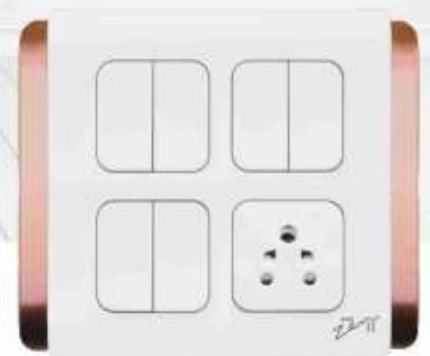

WHITE POLYCARBONATE



SILVER FINISH

Introducing
zen II
The smart switching range

PRODUCTS



ZN2-100 ZN2-101 ZN2-102



ZN2-103 ZN2-104



ZN2-105 ZN2-106 ZN2-107



ZN2-108 ZN2-109



ZN2-110 ZN2-111



ZN2-112 ZN2-113



ZN2-114 ZN2-114A



ZN2-115 ZN2-116



ZN2-118

Cat. No.	DESCRIPTION	LIST PRICE	HSN CODE	BOX/PCS.	CARTON PKG.
ZN2-100	One way switch 6A 250V AC ISI	89.00	8536	20 PCS.	400 Pcs.
ZN2-101	Two way switch 6A 250V AC ISI	206.00	8536	20 PCS.	-----
ZN2-102	Bell push 6A 250V AC ISI	213.00	8536	20 PCS.	-----
ZN2-103	Mega switch one way 6A 250V AC ISI	213.00	8536	10 PCS.	-----
ZN2-104	Mega two way switch 6A 250V AC ISI	226.00	8536	10 PCS.	-----
ZN2-105	Mega bell push 6A 250V AC ISI with led.	228.00	8536	10 PCS.	-----
ZN2-106	One way switch 16A 250V AC ISI	237.00	8536	10 PCS.	-----
ZN2-107	Mega one way switch 16A 250V AC ISI one way	245.00	8536	10 PCS.	-----
ZN2-108	Mega 16A switch one way 250V AC ISI with indicator	289.00	8536	10 PCS.	-----
ZN2-109	Mega 16A switch two way 250V AC	299.00	8536	10 PCS.	-----
ZN2-110	Mega double pole switch 16A 250V AC ISI	278.00	8536	10 PCS.	-----
ZN2-111	Mega single pole switch 32A 250V AC one way ISI	421.00	8536	10 PCS.	-----
ZN2-112	Mega double pole switch 32A 250V AC ISI	461.00	8536	10 PCS.	-----
ZN2-113	Mega double pole switch 32A 250V AC ISI with indicator	512.00	8536	10 PCS.	-----
ZN2-114	Mega 5 pin socket shuttered 6A 250V AC	195.00	8536	10 PCS.	140 PCS.
ZN2-114A	Mega universal socket 6A-13A 250V AC	327.00	8536	10 PCS.	140 PCS.
ZN2-115	6 pin socket shuttered 6A-16A 250V AC ISI	342.00	8536	10 PCS.	110 PCS.
ZN2-116	6 pin socket shuttered 6A-25A 250V AC ISI	369.00	8536	10 PCS.	110 PCS.
ZN2-118	Flat pin English socket 13A 250V AC	418.00	8536	10 PCS.	-----

PRODUCTS



ZN2-119



ZN2-120



ZN2-121



ZN2-122



ZN2-123



ZN2-124



ZN2-125



ZN2-126



ZN2-127



ZN2-128



ZN2-129



ZN2-130



ZN2-131



ZN2-132



ZN2-133



ZN2-137



ZN2-138



ZN2-134



ZN2-555



ZN2-139B



ZN2-139D



ZN2-1086



ZN2-142

Cat. No.

DESCRIPTION

LIST PRICE

HSN CODE

BOX/PCS.

ZN2-119 Shaver socket with switch 110V/250V AC 412.00

8536

10 PCS.

ZN2-120 Telephone socket 2 pin 2A 202.00

8517

20 PCS.

ZN2-121 Wall socket 2 pin 6A 250V AC 100.00

8536

20 PCS.

ZN2-122 Single telephone line jack 2 wire 198.00

8517

20 PCS.

ZN2-123 Single telephone line jack 4 wire 225.00

8517

20 PCS.

ZN2-124 Single telephone jack 2 wire socket size 215.00

8517

10 PCS.

ZN2-125 Single telephone jack 4 wire socket size 234.00

8517

10 PCS.

ZN2-126 Twin telephone jack 2 wire socket size 314.00

8517

10 PCS.

ZN2-127 Twin telephone jack 4 wire socket size 326.00

8517

10 PCS.

ZN2-128 T.V socket single outlet 204.00

8529

20 PCS.

ZN2-129 Mega T.V. socket single outlet 213.00

8538

10 PCS.

ZN2-130 Mega twin T.V. socket outlet 314.00

8538

10 PCS.

ZN2-131 Mega T.V. socket and Telephone line jack 330.00

8538

10 PCS.

ZN2-132 Fuse 16A 250V ac switch size 178.00

8536

20 PCS.

ZN2-133 Neon indicator switch size 126.00

8531

20 PCS.

ZN2-137 Blanking plate switch size 48.00

8538

20 PCS.

ZN2-138 Mega blanking plate 81.00

8538

10 PCS.

ZN2-134 Mega Neon indicator 141.00

8531

10 PCS.

ZN2-555 Energy Saver Foot Light 4"x3" 893.00

8531

05 PCS.

ZN2-139B Computer jack rj45 switch size 823.00

8536

10 PCS.

ZN2-139D Computer jack rj45 switch size cat. 6 985.00

8536

10 PCS.

ZN2-1086 Usb port 2 Amp. switch size 893.00

8536

10 PCS.

ZN2-142 Dimmer 300W 250V AC for light 516.00

8414

20 PCS.

PRODUCTS

Cat. No.

DESCRIPTION

LIST PRICE

HSN CODE

BOX/PCS.



ZN2-143 ZN2-144 ZN2-145

ZN2-143	Fan regulator switch size right 0-4 steps 100W hum free	588.00	8414	10 PCS.
ZN2-144	Mega dimmer 300W for light 250V AC	630.00	8414	10 PCS.
ZN2-145	Mega dimmer 500W for light 250V AC	790.00	8414	10 PCS.



ZN2-146 ZN2-147

ZN2-146	Mega regulator 0-4 steps 100W hum free	687.00	8414	10 PCS.
ZN2-147	Mega Electronic volume control	552.00	8531	10 PCS.



ZN2-148 ZN2-149

ZN2-148	Mega electronic buzzer	465.00	8531	10 PCS.
ZN2-149	Mega single phase motor starter 11A-18A	675.00	8536	10 PCS.



ZN2-150 ZN2-151

ZN2-150	Mega single phase motor starter 25A	712.00	8536	10 PCS.
ZN2-151	Switch socket combined 5 pin 6A socket and switch 6A 250V AC fitted with 4"x3" plate	538.00	8536	05 PCS.



ZN2-152 ZN2-153

ZN2-152	Switch socket combined 6 pin 16A socket and switch 6A 250V AC fitted with 4"x3" plate	608.00	8536	05 PCS.
ZN2-153	3 combined switches two way 6A 250V AC fitted with 4"x3" plate	638.00	8536	05 PCS.



ZN2-157 ZN2-159

ZN2-157	Energy switch 30A with key tag fitted with 3"x3" plate	1342.00	8536	05 PCS.
ZN2-159	Electronic energy saver foot light fitted with 5"x3" plate (L.E.D. Based)	1021.00	8531	05 PCS.



ZN2-1058 ZN2-1059 ZN2-167

ZN2-1058	Modular MCB 16A sp 'C' series switch size	470.00	8536	10 PCS.
ZN2-1059	Modular MCB 25A sp 'C' series switch size	470.00	8536	10 PCS.
ZN2-167	Mega modular MCB 32A DP	953.00	8536	05 PCS.



ZN2-1060 ZN2-1061























ZN2-1060	Modular MCB 16A sp 'C' series with 6 pin 16A socket fitted with 4"x3" plate	1351.00	8536	05 PCS.
ZN2-1061	Modular MCB 25A sp 'C' series with 6 pin 25A socket fitted with 4"x3" plate	1556.00	8536	05 PCS.



ZN2-160

ZN2-160	Do not disturb/clean my room with bell push suitable for 3"x3" box 1 switch do not disturb with LED, one switch clean my room with LED, fitted with 3"x3" plate	1030.00	8536	05 PCS.
---------	--	---------	------	---------

White Polycarbonate

PRODUCTS	Cat. No.	DESCRIPTION	LIST PRICE	HSN CODE	BOX/PCS.
  <p>ZN2-201 ZN2-202</p>	ZN2-201	Cover frame 1-2 module with powder coated steel plate 3"x3"	147.00	8538	10 PCS.
  <p>ZN2-203</p>	ZN2-202	Cover frame 3 module with powder coated steel plate 4"x3"	183.00	8538	10 PCS.
  <p>ZN2-204</p>	ZN2-203	Cover frame 4 module with powder coated steel plate 5"x3"	202.00	8538	10 PCS.
  <p>ZN2-209</p>	ZN2-204	Cover frame 6 module with powder coated steel plate 8"x3"	331.00	8538	10 PCS.
  <p>ZN2-205</p>	ZN2-209	Cover frame 8 module with powder coated steel plate 9"x3"	400.00	8538	10 PCS.
  <p>ZN2-206</p>	ZN2-205	Cover frame 8 module with powder coated steel plate 10"x3"	440.00	8538	10 PCS.
  <p>ZN2-206</p>	ZN2-206	Cover frame 8 module with powder coated steel plate 5"x5"	438.00	8538	10 PCS.
  <p>ZN2-207</p>	ZN2-207	Cover frame 8 module with powder coated steel plate 5"x5"	438.00	8538	10 PCS.
  <p>ZN2-210</p>	ZN2-207	Cover frame 12 module with powder coated steel plate 8"x6"	538.00	8538	10 PCS.
  <p>ZN2-210</p>	ZN2-210	Cover frame 16 module with powder coated steel plate 9"x6"	550.00	8538	05 PCS.
  <p>ZN2-208</p>	ZN2-208	Cover frame 18 module with powder coated steel plate 8"x8"	560.00	8538	05 PCS.



SILVER (SL), GRAPHITE GREY (G) FRAMES PAINTED WITH ROSE GOLD TIRMS

Graphite Grey (G)

Silver Finish (SL)

PRODUCTS	Cat. No.	DESCRIPTION	LIST PRICE	HSN CODE	BOX/PCS.
  ZN2-201 G, SL ZN2-202 G, SL	ZN2-201 G, SL	Cover frame 1-2 module with powder coated steel plate 3"x3"	183.00	8538	10 PCS.
 ZN2-202 G, SL	ZN2-202 G, SL	Cover frame 3 module with powder coated steel plate 4"x3"	224.00	8538	10 PCS.
 ZN2-203 G, SL	ZN2-203 G, SL	Cover frame 4 module with powder coated steel plate 5"x3"	250.00	8538	10 PCS.
 ZN2-204 G, SL	ZN2-204 G, SL	Cover frame 6 module with powder coated steel plate 8"x3"	410.00	8538	10 PCS.
 ZN2-209 G, SL	ZN2-209 G, SL	Cover frame 8 module with powder coated steel plate 9"x3"	529.00	8538	10 PCS.
 ZN2-205 G, SL	ZN2-205 G, SL	Cover frame 8 module with powder coated steel plate 10"x3"	535.00	8538	10 PCS.
 ZN2-206 G, SL	ZN2-206 G, SL	Cover frame 8 module with powder coated steel plate 5"x5"	514.00	8538	10 PCS.
 ZN2-207 G, SL	ZN2-207 G, SL	Cover frame 12 module with powder coated steel plate 8"x6"	682.00	8538	10 PCS.
 ZN2-210 G, SL	ZN2-210 G, SL	Cover frame 16 module with powder coated steel plate 9"x6"	691.00	8538	05 PCS.
 ZN2-208 G, SL	ZN2-208 G, SL	Cover frame 18 module with powder coated steel plate 8"x8"	700.00	8538	05 PCS.



metal
SERIES



A switch that knows
how to make a statement
unpretentious yet elegant.

PRODUCTS

Cat. No. DESCRIPTION LIST PRICE HSN CODE BOX/PCS. CARTON PKG.



MT-100	ONE WAY SWITCH 10AX 250V AC	137.00	8536	20 PCS.	400 Pcs.
MT-101	TWO WAY SWITCH 10AX 250V AC	195.00	8536	20 PCS.	---
MT-102	BELL PUSH 10AX 250V AC	198.00	8536	20 PCS.	---



MT-102A	MEGA BELL PUSH 10AX 250V AC	216.00	8536	10 PCS.	---
MT-104	ONE WAY SWITCH 6A 250V AC MEGA	182.00	8536	10 PCS.	---
MT-107	INTERMEDIATE SWITCH	694.00	8536	10 PCS.	---



MT-206	ONE WAY SWITCH 20AX 250V AC	237.00	8536	20 PCS.	---
MT-206A	ONE WAY SWITCH 20AX 250V AC WITH INDICATOR	289.00	8536	20 PCS.	---
MT-207	ONE WAY SWITCH 20AX 250V AC MEGA	245.00	8536	10 PCS.	---



MT-208	TWO WAY SWITCH 20AX 250V AC MEGA	275.00	8536	10 PCS.	---
MT-209	SINGLE POLE SWITCH 32A 250V AC ONE WAY MEGA	421.00	8536	10 PCS.	---
MT-210	DOUBLE POLE SWITCH 32A 250V AC ONE WAY MEGA	461.00	8536	10 PCS.	---



MT-211	DOUBLE POLE SWITCH 32A 250V AC ONE WAY MEGA WITH INDICATOR	466.00	8536	10 PCS.	---
MT-212	NEON IDICATOR	153.00	8531	10 PCS.	---
MT-213	DIMMER 500W 250V AC FOR LIGHT SWITCH SIZE	427.00	8414	10 PCS.	---



MT-213A	FAN REGULATOR 0-4 STEPS SWITCH SIZE 100W HUM FREE	600.00	8414	10 PCS.	---
MT-214	FAN REGULATOR 0-5 STEPS SOCKET SIZE 100W HUM FREE	727.00	8414	05 PCS.	---
MT-215	DIMMER 500W 250V AC FOR LIGHT SOCKET SIZE	626.00	8414	05 PCS.	---



MT-216	DIMMER 700W 250V AC FOR LIGHT SOCKET SIZE	835.00	8414	05 PCS.	---
MT-217	2 PIN SOCKET 6A 250V AC	100.00	8536	10 PCS.	---
MT-218	3 PIN SOCKET 6A 250V AC	202.00	8536	10 PCS.	---



MT-219	5 PIN SOCKET 6A 250V AC SHUTTERED	236.00	8536	10 PCS.	140 PCS.
MT-219A	6-13A UNIVERSAL SOCKET 250V AC	335.00	8536	10 PCS.	140 PCS.
MT-220	6 PIN SOCKET 6A-16A 250V AC SHUTTERED	356.00	8536	10 PCS.	110 PCS.

PRODUCTS

Cat. No. DESCRIPTION LIST PRICE HSN CODE BOX/PCS.



MT-220A MT-221 MT-222



MT-224 MT-225 MT-240



MT-240A MT-226 MT-250



MT-227 MT-228



MT-229A MT-229D



MT-231 MT-233



MT-234 MT-236



MT-777G MT-777A
MT-777SS

ITEMS ARE ALSO AVAILABLE IN ANTIQUE
AND STAINLESS STEEL FINISH.



MT-238 MT-235GL

MT-220A	6 PIN SOCKET 6A/25A 250V AC SHUTTERED	387.00	8538	10 PCS.
MT-221	3 PIN SOCKET 16A 250V AC	298.00	8538	10 PCS.
MT-222	SHAVER SOCKET WITH SWITCH 110V/ 250V AC	404.00	8538	10 PCS.
MT-224	SINGLE TELEPHONE LINE JACK 2 WIRE	198.00	8517	10 PCS.
MT-225	SINGLE TELEPHONE LINE JACK 4 WIRE	221.00	8517	10 PCS.
MT-240	TWIN TELEPHONE LINE JACK 2 WIRE	259.00	8517	10 PCS.
MT-240A	TWIN TELEPHONE LINE JACK 4 WIRE	314.00	8517	10 PCS.
MT-226	T. V. SOCKET SINGLE OUTLET	182.00	8529	10 PCS.
MT-250	ELECTRONIC BUZZER 250V AC	465.00	8531	10 PCS.
MT-227	1 MODULE BLANKING PLATE	48.00	8538	30 PCS.
MT-228	2 MODULE BLANKING PLATE	81.00	8538	20 PCS.
MT-229A	COMPUTER JACK RJ 45 FOR DATA TRANSFER SWITCH SIZE	823.00	8536	10 PCS.
MT-229D	COMPUTER JACK RJ 45 CAT 6 FOR DATA TRANSFER SWITCH SIZE	1004.00	8536	10 PCS.
MT-231	ELECTRONIC VOLUME CONTROL	552.00	8531	10 PCS.
MT-233	SINGLE PHASE MOTOR STARTER 11A-18A	675.00	8536	05 PCS.
MT-234	SINGLE PHASE MOTOR STARTER 25A	712.00	8536	05 PCS.
MT-236	FLAT PIN ENGLISH SOCKET 13A 250V AC	454.00	8536	10 PCS.
MT-777G	ELECTRONIC ENERGY SAVER FOOT LIGHT 24KT GOLD PLATED SUITABLE FOR 5"X 3"	2138.00	8531	10 PCS.
MT-777A	ELECTRONIC ENERGY SAVER FOOT LIGHT ANTIQUE FINISH SUITABLE FOR 5"X 3"	1257.00	8531	10 PCS.
MT-777SS	ELECTRONIC ENERGY SAVER FOOT LIGHT STAINLESS STEEL FINISH SUITABLE FOR 5"X 3"	1146.00	8531	10 PCS.
MT-238	DO NOT DISTURB CLEAN MY ROOM WITH BELL PUSH 6A 250V AC 24KT GOLD PLATED	2821.00	8536	05 PCS.
MT-235GL	ENERGY SWITCH 30A 250V AC WITH KEY TAG 24KT GOLD PLATED FITTED WITH 3"X3" FRAME	1883.00	8536	05 PCS.

PRODUCTS

Cat. No.

DESCRIPTION

LIST PRICE

HSN CODE

BOX/PCS.



MT-246

MT-246 USB CHARGING PORT 2 AMP.

910.00

8536

10 PCS.



MT-241



MT-242

MT-241 MODULAR MCB 16A SP 'C' SERIES

470.00

8536

10 PCS.

MT-242 MODULAR MCB 25A SP 'C' SERIES

470.00

8536

10 PCS.



MT-243



MT-244

MT-243 MODULAR MCB 16A SP 'C' SERIES WITH 6 PIN 16A SOCKET FITTED WITH 4"X 3" FRAME

1352.00

8536

05 PCS.

MT-244 MODULAR MCB 25A SP 'C' SERIES WITH 6 PIN 16A SOCKET FITTED WITH 4"X 3" FRAME

1555.00

8536

05 PCS.

COVER FRAMES IN 24KT GOLD PLATED



MT-260GL



MT-261GL

MT-260GL 1M COVER FRAME GOLD PLATED WITH POWDER COATED STEEL PLATE 3"X 3"

1193.00

8538

10 PCS.

MT-261GL 2M COVER FRAME GOLD PLATED WITH POWDER COATED STEEL PLATE 3"X 3"

1193.00

8538

10 PCS.



MT-262GL



MT-263GL

MT-262GL 3M COVER FRAME GOLD PLATED WITH POWDER COATED STEEL PLATE 4"X 3"

1367.00

8538

10 PCS.

MT-263GL 4M COVER FRAME GOLD PLATED WITH POWDER COATED STEEL PLATE 5"X 3"

1591.00

8538

10 PCS.



MT-264KGL



MT-264AGL

MT-264KGL 6M COVER FRAME GOLD PLATED WITH POWDER COATED STEEL PLATE 7"X 3"

1922.00

8538

10 PCS.

MT-264AGL 6M COVER FRAME GOLD PLATED WITH POWDER COATED STEEL PLATE 8"X 3"

2217.00

8538

10 PCS.



MT-264GL



MT-265KGL

MT-264GL 7M COVER FRAME GOLD PLATED WITH POWDER COATED STEEL PLATE 8"X 3"

2322.00

8538

10 PCS.

MT-265KGL 8M COVER FRAME GOLD PLATED WITH POWDER COATED STEEL PLATE 9"X 3"

2674.00

8538

10 PCS.



MT-265GL

MT-265GL 9M COVER FRAME GOLD PLATED WITH POWDER COATED STEEL PLATE 10"X 3"

2940.00

8538

10 PCS.



MT-266GL



MT-267GL

MT-266GL 8M COVER FRAME GOLD PLATED WITH POWDER COATED STEEL PLATE 5"X 5"

2271.00

8538

10 PCS.

MT-267GL 8M COVER FRAME GOLD PLATED WITH POWDER COATED STEEL PLATE 6"X 5"

2567.00

8538

05 PCS.



MT-268GL



MT-269GL

MT-268GL 14M COVER FRAME GOLD PLATED WITH POWDER COATED STEEL PLATE 8"X 6"

3865.00

8538

05 PCS.

MT-269GL 21M COVER FRAME GOLD PLATED WITH POWDER COATED STEEL PLATE 8"X 8"

4744.00

8538

05 PCS.

PRODUCTS

Cat. No.

DESCRIPTION

LIST PRICE

HSN CODE

BOX/PCS.



MT-260SS



MT-261SS

MT-260SS

1M COVER FRAME STAINLESS STEEL WITH POWDER COATED STEEL PLATE 3"X 3"

418.00

8538

10 PCS.

MT-261SS

2M COVER FRAME STAINLESS STEEL WITH POWDER COATED STEEL PLATE 3"X 3"

418.00

8538

10 PCS.



MT-262SS



MT-263SS

MT-262SS

3M COVER FRAME STAINLESS STEEL WITH POWDER COATED STEEL PLATE 4"X 3"

552.00

8538

10 PCS.

MT-263SS

4M COVER FRAME STAINLESS STEEL WITH POWDER COATED STEEL PLATE 5"X 3"

591.00

8538

10 PCS.



MT-264KSS



MT-264ASS

MT-264KSS

6M COVER FRAME STAINLESS STEEL WITH POWDER COATED STEEL PLATE 7"X 3"

773.00

8538

10 PCS.

MT-264ASS

6M COVER FRAME STAINLESS STEEL WITH POWDER COATED STEEL PLATE 8"X 3"

857.00

8538

10 PCS.



MT-264SS



MT-265KSS

MT-264SS

7M COVER FRAME STAINLESS STEEL WITH POWDER COATED STEEL PLATE 8"X 3"

857.00

8538

10 PCS.

MT-265KSS

8M COVER FRAME STAINLESS STEEL WITH POWDER COATED STEEL PLATE 9"X 3"

1136.00

8538

10 PCS.



MT-265SS

MT-265SS

9M COVER FRAME STAINLESS STEEL WITH POWDER COATED STEEL PLATE 10"X 3"

1248.00

8538

10 PCS.



MT-266SS

MT-266SS

8M COVER FRAME STAINLESS STEEL WITH POWDER COATED STEEL PLATE 5"X 5"

1027.00

8538

10 PCS.



MT-267SS

MT-267SS

8M COVER FRAME STAINLESS STEEL WITH POWDER COATED STEEL PLATE 6"X 5"

1074.00

8538

05 PCS.



MT-268SS

MT-268SS

14M COVER FRAME STAINLESS STEEL WITH POWDER COATED STEEL PLATE 8"X 6"

1391.00

8538

05 PCS.



MT-269SS

MT-269SS

21M COVER FRAME STAINLESS STEEL WITH POWDER COATED STEEL PLATE 8"X 8"

1852.00

8538

05 PCS.

PRODUCTS

Cat. No.

DESCRIPTION

LIST PRICE

HSN CODE

BOX/PCS.



MT-260AQ



MT-261AQ

MT-260AQ

1M COVER FRAME ANTIQUE FINISH WITH POWDER COATED STEEL PLATE 3"X 3"

454.00

8538

10 PCS.

MT-261AQ

1M COVER FRAME ANTIQUE FINISH WITH POWDER COATED STEEL PLATE 3"X 3"

454.00

8538

10 PCS.



MT-262AQ



MT-263AQ

MT-262AQ

3M COVER FRAME ANTIQUE FINISH WITH POWDER COATED STEEL PLATE 4"X 3"

591.00

8538

10 PCS.

MT-263AQ

4M COVER FRAME ANTIQUE FINISH WITH POWDER COATED STEEL PLATE 5"X 3"

644.00

8538

10 PCS.



MT-264KAQ



MT-264AAQ

MT-264KAQ

6M COVER FRAME ANTIQUE FINISH WITH POWDER COATED STEEL PLATE 7"X 3"

836.00

8538

10 PCS.

MT-264AAQ

6M COVER FRAME ANTIQUE FINISH WITH POWDER COATED STEEL PLATE 8"X 3"

942.00

8538

10 PCS.



MT-264AQ



MT-265KAQ

MT-264AQ

7M COVER FRAME ANTIQUE FINISH WITH POWDER COATED STEEL PLATE 8"X 3"

942.00

8538

10 PCS.

MT-265KAQ

8M COVER FRAME ANTIQUE FINISH WITH POWDER COATED STEEL PLATE 9"X 3"

1248.00

8538

10 PCS.



MT-265AQ

MT-265AQ

9M COVER FRAME ANTIQUE FINISH WITH POWDER COATED STEEL PLATE 10"X 3"

1367.00

8538

10 PCS.



MT-266AQ

MT-266AQ

8M COVER FRAME ANTIQUE FINISH WITH POWDER COATED STEEL PLATE 5"X 5"

1127.00

8538

10 PCS.



MT-267AQ

MT-267AQ

8M COVER FRAME ANTIQUE FINISH WITH POWDER COATED STEEL PLATE 6"X 5"

1174.00

8538

05 PCS.

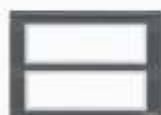

MT-268AQ

MT-268AQ

14M COVER FRAME ANTIQUE FINISH WITH POWDER COATED STEEL PLATE 8"X 6"

1525.00

8538

05 PCS.



MT-269AQ

MT-269AQ

21M COVER FRAME ANTIQUE FINISH WITH POWDER COATED STEEL PLATE 8"X 8"

2037.00

8538

05 PCS.



CROWN
COLLECTION
MARK -II



Mirror Finish



























Brushed Stainless Steel



Wood Finish

ASSK
Electrical Excellence
Since 1935

PRODUCTS

PRODUCTS			Cat. No.	DESCRIPTION	LIST PRICE	HSN CODE	BOX/PCS.	CARTON PKG.
			CM2-1000	One way switch 10AX 250V AC ISI	142.00	8536	20 PCS.	400 Pcs.
			CM2-1001	Two way switch 10AX 250V AC ISI	162.00	8536	10 PCS.	-----
			CM2-1002	Bell push 10AX 250V AC ISI	165.00	8536	10 PCS.	-----
			CM2-1003	Mega bell push 10AX 250V AC ISI	387.00	8536	10 PCS.	-----
			CM2-1004	Mega one way switch 10AX 250V AC ISI	238.00	8536	10 PCS.	-----
			CM2-1005	Intermediate switch	837.00	8536	10 PCS.	-----
			CM2-1006	One way switch 20AX 250V AC ISI	295.00	8536	10 PCS.	-----
			CM2-1007	One way switch 20AX 250V AC ISI with indicator	322.00	8536	10 PCS.	-----
			CM2-1008	One way switch 20AX 250V AC ISI mega	316.00	8536	10 PCS.	-----
			CM2-1009	Two way switch 20AX 250V AC ISI mega	345.00	8536	10 PCS.	-----
			CM2-1010	Single pole switch 32A 250V AC ISI one way mega	323.00	8536	10 PCS.	-----
			CM2-1011	Double pole switch 32A 250V AC ISI one way mega	601.00	8536	10 PCS.	-----
			CM2-1012	Double pole switch 32A 250V AC ISI one way mega with indicator	619.00	8536	10 PCS.	-----
			CM2-1062	DP switch 20A 250V AC	426.00	8536	10 PCS.	-----
			CM2-1063	DP switch 45A 250V AC	943.00	8536	10 PCS.	-----
			CM2-1019	2 Pin socket 6A 250V AC	114.00	8536	10 PCS.	-----
			CM2-1020	3 Pin socket 6A 250V AC	177.00	8536	10 PCS.	-----
			CM2-1021	5 pin socket 6A 250V AC shuttered	219.00	8536	10 PCS.	140 PCS.
			CM2-1022	Universal socket 6A-13A 250V AC	285.00	8536	10 PCS.	140 PCS.
			CM2-1023	6 Pin socket 6A-16A 250V AC shuttered	299.00	8536	10 PCS.	110 PCS.
			CM2-1024	6 Pin socket 6A-25A 250V AC shuttered	314.00	8536	10 PCS.	110 PCS.
			CM2-1025	3 pin socket 16A 250V AC	266.00	8536	10 PCS.	-----
			CM2-1026	Shaver socket with switch 110V/250V AC	456.00	8536	10 PCS.	-----
			CM2-1043	Flat pin English socket 13A 250V AC	238.00	8536	10 PCS.	-----

PRODUCTS



CM2-1015



CM2-1016



CM2-1017



CM2-1018



CM2-1014



CM2-1013



CM2-1027



CM2-1028



CM2-1029



CM2-1030



CM2-1031



CM2-1032



CM2-1033



CM2-1034



CM2-1035



CM2-1036



CM2-1037



CM2-1038



CM2-1039



CM2-1040



CM2-1041



CM2-1086



CM2-1058



CM2-1059

Cat. No.	DESCRIPTION	LIST PRICE	HSN CODE	BOX/PCS.
CM2-1015	Fan regulator 0-4 steps switch size 100W hum free	551.00	8414	10 PCS.
CM2-1016	Fan regulator 0-5 steps socket size 100W hum free	689.00	8414	05 PCS.
CM2-1017	Dimmer 500W AC for light socket size	561.00	8414	05 PCS.
CM2-1018	Dimmer 700W AC for light socket size	618.00	8414	05 PCS.
CM2-1014	Dimmer 500W AC for light switch size	475.00	8414	10 PCS.
CM2-1013	Neon indicator switch size	135.00	8531	10 PCS.
CM2-1027	Single telephone in jack 2 wire switch size	173.00	8517	10 PCS.
CM2-1028	Single telephone in jack 4 wire switch size	219.00	8517	10 PCS.
CM2-1029	Twin telephone in jack 2 wire switch size	260.00	8517	10 PCS.
CM2-1030	Twin telephone in jack 4 wire switch size	285.00	8517	10 PCS.
CM2-1031	TV socket single outlet switch size	157.00	8529	10 PCS.
CM2-1032	Blanking plate switch size	63.00	8538	30 PCS.
CM2-1033	Mega blanking plate	85.00	8538	20 PCS.
CM2-1034	Computer jack RJ 45 for data transfer cat. 5	523.00	8536	10 PCS.
CM2-1035	Computer jack RJ 45 for data transfer cat. 5 switch size	499.00	8536	10 PCS.
CM2-1036	Computer jack RJ 45 for data transfer cat. 6 switch size	969.00	8536	10 PCS.
CM2-1037	Mega computer jack RJ 45 for data transfer cat. 6 switch size	1036.00	8536	10 PCS.
CM2-1038	Mega electronic volume control	656.00	8531	10 PCS.
CM2-1039	Fuse 16A-25A 250V AC switch size	177.00	8536	10 PCS.
CM2-1040	Mega single phase motor starter 11A-18A	570.00	8536	05 PCS.
CM2-1041	Mega single phase motor starter 25A	709.00	8536	05 PCS.
CM2-1086	Usb charging port 2 Amp. switch size	1093.00	8536	10 PCS.
CM2-1058	Modular MCB 16A SP 'C' series switch size	468.00	8536	10 PCS.
CM2-1059	Modular MCB 25A SP 'C' series switch size	468.00	8536	10 PCS.

PRODUCTS



CM2-1066 CM2-1067



CM2-1060
WD/SS/MR



CM2-1061
WD/SS/MR



CM2-1044
WD/SS/MR



CM2-1045
WD/SS/MR



CM2-1042
WD/SS/MR

Cat. No.	DESCRIPTION	LIST PRICE	HSN CODE	BOX/PCS.
----------	-------------	------------	----------	----------

CM2-1066	Modular Mcb 32A SP 'C' series switch size	468.00	8536	10 PCS.
CM2-1067	Mega Modular Mcb 32A DP 'C' series	998.00	8536	10 PCS.

CM2-1060	Modular Mcb 16A SP 'C' series with 16A socket fitted with 4"x3" plate			
CM2-1060	S.S. Laminite Finish	1044.00	8536	05 PCS.
CM2-1060	MR. S.S. Finish	1177.00		
CM2-1060	MR. Mirror Finish	1234.00		

CM2-1061	Modular Mcb 25A SP 'C' series with 25A socket fitted with 4"x3" plate			
CM2-1061	S.S. Laminite Finish	1064.00	8536	05 PCS.
CM2-1061	MR. S.S. Finish	1405.00		
CM2-1061	MR. Mirror Finish	1462.00		

CM2-1044	Electronic Energy Saver Foot Light With 5"x3" plate			
CM2-1044	S.S. Laminite Finish	1139.00	8531	05 PCS.
CM2-1044	MR. S.S. Finish	1238.00		
CM2-1044	MR. Mirror Finish	1329.00		

CM2-1045	Don not disturb clean my room with bell push fitted with 3"x3" plate			
CM2-1045	S.S. Laminite Finish	1153.00	8536	05 PCS.
CM2-1045	MR. S.S. Finish	1214.00		
CM2-1045	MR. Mirror Finish	1334.00		

CM2-1042	Energy switch 30A 250V AC with key tag fitted with 4"x3" plate			
CM2-1042	S.S. Laminite Finish	1951.00	8536	05 PCS.
CM2-1042	MR. S.S. Finish	2374.00		
CM2-1042	MR. Mirror Finish	2445.00		

PRODUCTS

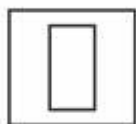

CM2-1046
WD/S.S./MR.

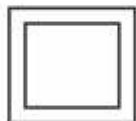

CM2-1047
WD/S.S./MR.

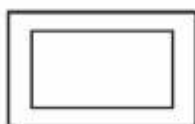

CM2-1048
WD/S.S./MR.

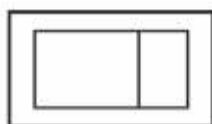

CM2-1049
C/WD/S.S./MR.

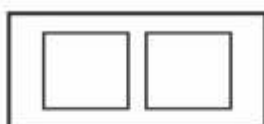

CM2-1050
C/WD/S.S./MR.

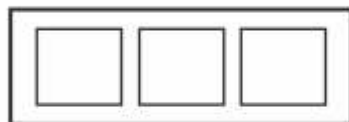

CM2-1051
C/WD/S.S./MR.

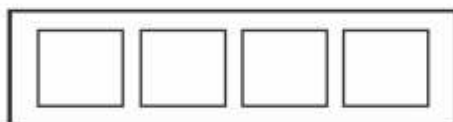

CM2-1052
C/WD/S.S./MR.

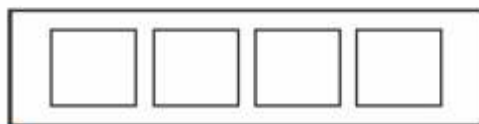

CM2-1053
C/WD/S.S./MR.

Cat. No.	DESCRIPTION	LIST PRICE	HSN CODE	BOX/PCS.
CM2-1046 WD	Laminate Finish	341.00		
CM2-1046 S.S.	Cage / Frame 1 Module 3"X3"	S.S. Finish 454.00	8538	10 PCS.
CM2-1046 MR.	Mirror Finish	473.00		
CM2-1047 WD	Laminate Finish	341.00		
CM2-1047 S.S.	Cage / Frame 2 Module 3"X3"	S.S. Finish 454.00	8538	10 PCS.
CM2-1047 MR.	Mirror Finish	473.00		
CM2-1048 WD	Laminate Finish	436.00		
CM2-1048 S.S.	Cage / Frame 3 Module 4"X3"	S.S. Finish 565.00	8538	10 PCS.
CM2-1048 MR.	Mirror Finish	589.00		
CM2-1049 WD	Laminate Finish	436.00		
CM2-1049 S.S.	Cage / Frame for Switch & Socket 3 Module 4"X3"	S.S. Finish 565.00	8538	10 PCS.
CM2-1049 MR.	Mirror Finish	589.00		
CM2-1050 WD	Laminate Finish	512.00		
CM2-1050 S.S.	Cage / Frame 4 Module 5"X3"	S.S. Finish 673.00	8538	10 PCS.
CM2-1050 MR.	Mirror Finish	702.00		
CM2-1051 WD	Laminate Finish	901.00		
CM2-1051 S.S.	Cage / Frame 6 Module 8"X3"	S.S. Finish 1064.00	8538	10 PCS.
CM2-1051 MR.	Mirror Finish	1101.00		
CM2-1052 WD	Laminate Finish	1043.00		
CM2-1052 S.S.	Cage / Frame 8 Module 9"X3"	S.S. Finish 1205.00	8538	10 PCS.
CM2-1052 MR.	Mirror Finish	1243.00		
CM2-1053 WD	Laminate Finish	1130.00		
CM2-1053 S.S.	Cage / Frame 8 Module 10"X3"	S.S. Finish 1312.00	8538	10 PCS.
CM2-1053 MR.	Mirror Finish	1368.00		

PRODUCTS

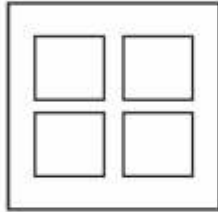

CM2-1054
C/WD/S.S./MR.

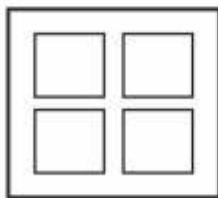

CM2-1055
C/WD/S.S./MR.

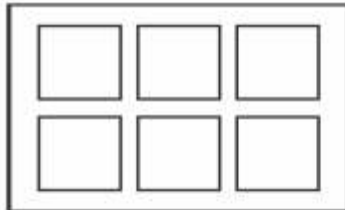

CM2-1056
C/WD/S.S./MR.

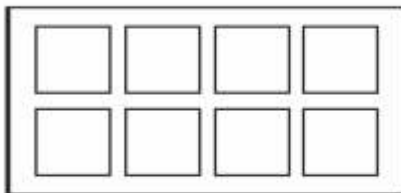

CM2-1068
C/WD/S.S./MR.

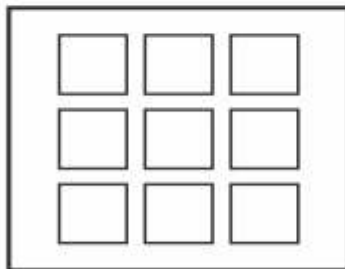

CM2-1057
C/WD/S.S./MR.

Cat. No.	DESCRIPTION	LIST PRICE	HSN CODE	BOX/PCS.
----------	-------------	------------	----------	----------

CM2-1054 WD	Laminate Finish	1053.00		
CM2-1054 S.S.	Cage / Frame 8 Module 5"X5"	S.S. Finish 1263.00	8538	10 PCS.
CM2-1054 MR.	Mirror Finish	1309.00		

CM2-1055 WD	Laminate Finish	1129.00		
CM2-1055 S.S.	Cage / Frame 8 Module 5"X6"	S.S. Finish 1281.00	8538	05 PCS.
CM2-1055 MR.	Mirror Finish	1319.00		

CM2-1056 WD	Laminate Finish	1395.00		
CM2-1056 S.S.	Cage / Frame 12 Module 8"X6"	S.S. Finish 1756.00	8538	05 PCS.
CM2-1056 MR.	Mirror Finish	1786.00		

CM2-1068 WD	Laminate Finish	2014.00		
CM2-1068 S.S.	Cage / Frame 16 Module 9"X6"	S.S. Finish 2527.00	8538	05 PCS.
CM2-1068 MR.	Mirror Finish	2574.00		

CM2-1057 WD	Laminate Finish	2136.00		
CM2-1057 S.S.	Cage / Frame 18 Module 8"X8"	S.S. Finish 2706.00	8538	05 PCS.
CM2-1057 MR.	Mirror Finish	2801.00		



MIRROR FINISH
STAINLESS STEEL



BRUSHED FINISH
STAINLESS STEEL



WOOD FINISH
OUT OF HARD
SCRATCH RESISTANT LAMINATES



SSK
Electrical Excellence
Since 1935

CROWN
COLLECTION



Wood Finish



Mirror Finish

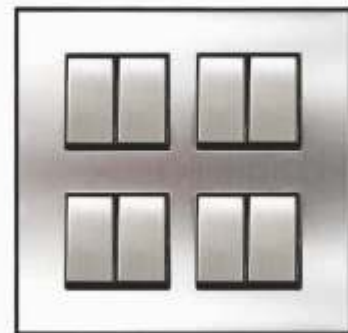

Brushed
Stainless Steel

PRODUCTS

CR-1000

CR-1001

CR-1002

CR-1003

CR-1004

CR-1005

CR-1006

CR-1007

CR-1008

CR-1009

CR-1010

CR-1011

CR-1012

CR-1062

CR-1063

CR-1019

CR-1020

CR-1021

CR-1022

CR-1023

CR-1024

CR-1025

CR-1026

CR-1043
Cat. No.
DESCRIPTION
LIST PRICE
HSN CODE
BOX/PCS.

CR-1000 One way switch 10AX 250V AC ISI 149.00

8536 20 PCS.

CR-1001 Two way switch 10AX 250V AC ISI 171.00

8536 10 PCS.

CR-1002 Bell push 10AX 250V AC ISI 174.00

8536 10 PCS.

CR-1003 Mega bell push 10AX 250V AC ISI 407.00

8536 10 PCS.

CR-1004 Mega one way switch 10AX 250V AC ISI 250.00

8536 10 PCS.

CR-1005 Intermediate switch 878.00

8536 10 PCS.

CR-1006 One way switch 20AX 250V AC ISI 311.00

8536 10 PCS.

CR-1007 One way switch 20AX 250V AC ISI with indicator 339.00

8536 10 PCS.

CR-1008 One way switch 20AX 250V AC ISI mega 333.00

8536 10 PCS.

CR-1009 Two way switch 20AX 250V AC ISI mega 363.00

8536 10 PCS.

CR-1010 Single pole switch 32A 250V AC ISI one way mega 340.00

8536 10 PCS.

CR-1011 Double pole switch 32A 250V AC ISI one way mega 633.00

8536 10 PCS.

CR-1012 Double pole switch 32A 250V AC ISI one way mega with indicator 652.00

8536 10 PCS.

CR-1062 DP switch 20A 250V AC 448.00

8536 10 PCS.

CR-1063 DP switch 45A 250V AC 990.00

8536 10 PCS.

CR-1019 2 Pin socket 6A 250V AC 120.00

8536 10 PCS.

CR-1020 3 Pin socket 6A 250V AC 186.00

8536 10 PCS.

CR-1021 5 pin socket 6A 250V AC shuttered 230.00

8536 10 PCS.

CR-1022 Universal socket 6A-13A 250V AC 300.00

8536 10 PCS.

CR-1023 6 Pin socket 6A-16A 250V AC shuttered 315.00

8536 10 PCS.

CR-1024 6 Pin socket 6A-25A 250V AC shuttered 331.00

8536 10 PCS.

CR-1025 3 pin socket 16A 250V AC 280.00

8536 10 PCS.

CR-1026 Shaver socket with switch 110V/250V AC 480.00

8536 10 PCS.

CR-1043 Flat pin English socket 13A 250V AC 250.00

8536 10 PCS.

PRODUCTS



CR-1015 CR-1016 CR-1017



CR-1018 CR-1014 CR-1013 CR-1027



CR-1028 CR-1029 CR-1030 CR-1031



CR-1032 CR-1033 CR-1034



CR-1035 CR-1036 CR-1037



CR-1038 CR-1039 CR-1040



CR-1041 CR-1086



CR-1058 CR-1059

Cat. No.	DESCRIPTION	LIST PRICE	HSN CODE	BOX/PCS.
CR-1015	Fan regulator 0-4 steps switch size 100W hum free	580.00	8414	10 PCS.
CR-1016	Fan regulator 0-5 steps socket size 100W hum free†	725.00	8414	05 PCS.
CR-1017	Dimmer 500W AC for light socket size	590.00	8414	05 PCS.
CR-1018	Dimmer 700W AC for light socket size	650.00	8414	05 PCS.
CR-1014	Dimmer 500W AC for light switch size	500.00	8414	10 PCS.
CR-1013	Neon indicator switch size	142.00	8531	10 PCS.
CR-1027	Single telephone in jack 2 wire switch size	182.00	8517	10 PCS.
CR-1028	Single telephone in jack 4 wire switch size	230.00	8517	10 PCS.
CR-1029	Twin telephone in jack 2 wire switch size	274.00	8517	10 PCS.
CR-1030	Twin telephone in jack 4 wire switch size	300.00	8517	10 PCS.
CR-1031	TV socket single outlet switch size	165.00	8529	10 PCS.
CR-1032	Blanking plate switch size	66.00	8538	30 PCS.
CR-1033	Mega blanking plate	89.00	8538	20 PCS.
CR-1034	Computer jack RJ 45 for data transfer cat. 5	550.00	8536	10 PCS.
CR-1035	Computer jack RJ 45 for data transfer cat. 5 switch size	525.00	8536	10 PCS.
CR-1036	Computer jack RJ 45 for data transfer cat. 6 switch size	1020.00	8536	10 PCS.
CR-1037	Mega computer jack RJ 45 for data transfer cat. 6 switch size	1090.00	8536	10 PCS.
CR-1038	Mega electronic volume control	690.00	8531	10 PCS.
CR-1039	Fuse 16A-25A 250V AC switch size	186.00	8536	10 PCS.
CR-1040	Mega single phase motor starter 11A-18A	600.00	8536	05 PCS.
CR-1041	Mega single phase motor starter 25A	746.00	8536	05 PCS.
CR-1086	Usb charging port 2 Amp. switch size	1150.00	8536	10 PCS.
CR-1058	Modular MCB 16A 3P 'C' series switch size	493.00	8536	10 PCS.
CR-1059	Modular MCB 25A 3P 'C' series switch size	493.00	8536	10 PCS.

PRODUCTS



CR-1066

CR-1067



CR-1042

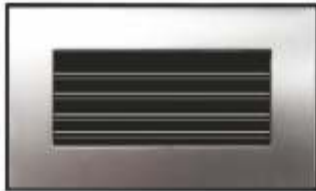

CR-1044



CR-1045





CR-1060



CR-1061

Cat. No.	DESCRIPTION	LIST PRICE	HSN CODE	BOX/PCS.
CR-1066	Modular Mcb 32A SP 'C' series switch size	493.00	8536	10 PCS.
CR-1067	Mega Modular Mcb 32A DP 'C' series	1050.00	8536	10 PCS.
CR-1042 WD		LAMINATE FINISH 2048.00		
CR-1042 SS	Energy switch 30A 250V AC with key tag fitted with 4"x3" plate.	S.S. FINISH 2499.00	8536	05 PCS.
CR-1042 MR		MIRROR FINISH 2574.00		
CR-1044 WD		LAMINATE FINISH 1199.00		
CR-1044 SS	Electronic Energy Saver Foot Light With 5"x3" plate.	S.S. FINISH 1303.00	8531	05 PCS.
CR-1044 MR		MIRROR FINISH 1399.00		
CR-1045 WD		LAMINATE FINISH 1211.00		
CR-1045 SS	Don not disturb clean my room with bell push fitted with 3"x3" plate	S.S. FINISH 1275.00	8536	05 PCS.
CR-1045 MR		MIRROR FINISH 1401.00		
CR-1060 WD		LAMINATE FINISH 1099.00		
CR-1060 SS	Modular Mcb 1.6A SP 'C' series with 1.6A socket fitted with 4"x3" plate	S.S. FINISH 1239.00	8536	05 PCS.
CR-1060 MR		MIRROR FINISH 1299.00		
CR-1061 WD		LAMINATE FINISH 1120.00		
CR-1061 SS	Modular Mcb 2.5A SP 'C' series with 2.5A socket fitted with 4"x3" plate	S.S. FINISH 1479.00	8536	05 PCS.
CR-1061 MR		MIRROR FINISH 1539.00		

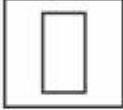
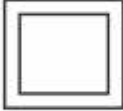
PRICES ARE WITH CAGE AND FRAME

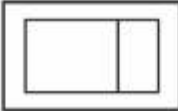
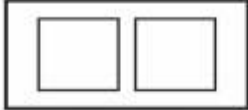
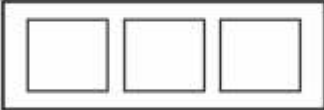
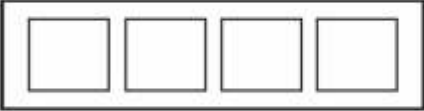
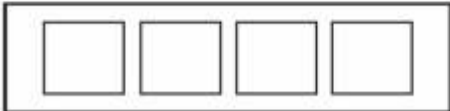
PRODUCTS	Cat. No.	DESCRIPTION	LIST PRICE	HSN CODE	BOX/PCS.
	CR-1046 WD	Laminate Finish	359.00		
CR-1046	CR-1046 SS	Cage / Frame 1 Module 3"X3"	S.S. Finish 478.00	8538	10 PCS.
	CR-1046 MR	Mirror Finish	498.00		
	CR-1047 WD	Mirror Finish	359.00		
CR-1047	CR-1047 SS	Cage / Frame 2 Module 3"X3"	S.S. Finish 478.00	8538	10 PCS.
	CR-1047 MR	Mirror Finish	498.00		
	CR-1048 WD	Laminate Finish	458.00		
CR-1048	CR-1048 SS	Cage / Frame 3 Module 4"X3"	S.S. Finish 594.00	8538	10 PCS.
	CR-1048 MR	Mirror Finish	619.00		
	CR-1049 WD	Laminate Finish	458.00		
CR-1049	CR-1049 SS	Cage / Frame for Switch & Socket 3 Module 4"X3"	S.S. Finish 594.00	8538	10 PCS.
	CR-1049 MR	Mirror Finish	619.00		
	CR-1050 WD	Laminate Finish	538.00		
CR-1050	CR-1050 SS	Cage / Frame 4 Module 5"X3"	S.S. Finish 708.00	8538	10 PCS.
	CR-1050 MR	Mirror Finish	738.00		
	CR-1051 WD	Laminate Finish	948.00		
CR-1051	CR-1051 SS	Cage / Frame 6 Module 8"X3"	S.S. Finish 1119.00	8538	10 PCS.
	CR-1051 MR	Mirror Finish	1158.00		
	CR-1052 WD	Laminate Finish	1098.00		
CR-1052	CR-1052 SS	Cage / Frame 8 Module 9"X3"	S.S. Finish 1268.00	8538	10 PCS.
	CR-1052 MR	Mirror Finish	1308.00		
	CR-1053 WD	Laminate Finish	1189.00		
CR-1053	CR-1053 SS	Cage / Frame 8 Module 10"X3"	S.S. Finish 1380.00	8538	10 PCS.
	CR-1053 MR	Mirror Finish	1439.00		

PRICES ARE WITH CAGE AND FRAME

PRODUCTS	Cat. No.	DESCRIPTION	LIST PRICE	HSN CODE	BOX/PCS.
 <p>CR-1054</p>	CR-1054 WD		LAMINATE FINISH 1108.00		
	CR-1054 SS	Cage / Frame 8 Module 5"X5"	S.S. FINISH 1329.00	8538	10 PCS.
	CR-1054 MR		MIRROR FINISH 1378.00		
 <p>CR-1055</p>	CR-1055 WD		LAMINATE FINISH 1188.00		
	CR-1055 SS	Cage / Frame 8 Module 5"X6"	S.S. FINISH 1348.00	8538	05 PCS.
	CR-1055 MR		MIRROR FINISH 1388.00		
 <p>CR-1056</p>	CR-1056 WD		LAMINATE FINISH 1468.00		
	CR-1056 SS	Cage / Frame 12 Module 8"X6"	S.S. FINISH 1848.00	8538	05 PCS.
	CR-1056 MR		MIRROR FINISH 1879.00		
 <p>CR-1068</p>	CR-1068 WD		LAMINATE FINISH 2119.00		
	CR-1068 SS	Cage / Frame 16 Module 9"X6"	S.S. FINISH 2659.00	8538	05 PCS.
	CR-1068 MR		MIRROR FINISH 2709.00		
 <p>CR-1057</p>	CR-1057 WD		LAMINATE FINISH 2248.00		
	CR-1057 SS	Cage / Frame 18 Module 8"X8"	S.S. FINISH 2848.00	8538	05 PCS.
	CR-1057 MR		MIRROR FINISH 2948.00		



MIRROR FINISH
STAINLESS STEEL



BRUSHED FINISH
STAINLESS STEEL



WOOD FINISH
OUT OF HARD
SCRATCH RESISTANT LAMINATES



*Signature.*EL.

This range has a highly positive geometry and periphery. Which can immediately be riveted with contemporary interiors. Our product quality has been perfected over the years to match up our exacting standards.

ASK
Electrical Excellence
Since 1935

PRODUCTS

Cat. No. DESCRIPTION LIST PRICE HSN CODE BOX/PCS. CARTON PKG.



EL-200 EL-201 EL-202

EL-200	SINGLE ONE WAY SWITCH 6A 250V AC ISI	207.00	8536	10 PCS.	400 Pcs.
EL-201	TWIN SWITCH ONE WAY 6A 250V AC ISI	279.00	8536	10 PCS.	-----
EL-202	SINGLE SWITCH TWO WAY 6A 250V AC ISI	204.00	8536	10 PCS.	-----



EL-203 EL-209 EL-210

EL-203	TWIN SWITCH TWO WAY 6A 250V AC ISI	356.00	8536	10 PCS.	-----
EL-209	MEGA BELL PUSH 6A 250V AC ISI	216.00	8536	10 PCS.	-----
EL-210	TWIN BELL PUSH 6A 250V AC ISI	354.00	8536	10 PCS.	-----



EL-211 EL-212 EL-213

EL-211	BELL PUSH AND SINGLE SWITCH TWO WAY 6A 250V AC ISI	351.00	8536	10 PCS.	-----
EL-212	TWO WAY SWITCH 6A 250V AC ISI	209.00	8536	20 PCS.	-----
EL-213	BELL PUSH 6A 250V AC	174.00	8536	20 PCS.	-----



EL-204 EL-204A EL-205

EL-204	DP SWITCH 16A 250V AC ISI	275.00	8536	10 PCS.	-----
EL-204A	MEGA SWITCH ONE WAY 16A 250V AC ISI WITH INDICATOR	269.00	8536	10 PCS.	-----
EL-205	MEGA SWITCH ONE WAY 16A 250V AC ISI	243.00	8536	10 PCS.	-----



EL-205A EL-205B EL-205C

EL-205A	MEGA SWITCH SP 32A 250V AC ISI	329.00	8536	10 PCS.	-----
EL-205B	MEGA DP SWITCH 32A 250V AC ISI	348.00	8536	10 PCS.	-----
EL-205C	MEGA DP SWITCH WITH INDICATOR 32A 250V AC ISI	404.00	8536	10 PCS.	-----



EL-206 EL-206A EL-207

EL-206	TWIN SWITCH ONE WAY 16A 250V AC ISI	414.00	8536	10 PCS.	-----
EL-206A	TWIN SWITCH ONE WAY WITH INDICATOR 16A 250V AC ISI	456.00	8536	10 PCS.	-----
EL-207	MEGA TWO WAY SWITCH 16A 250V AC ISI	274.00	8536	10 PCS.	-----



EL-216 EL-248 EL-220

EL-216	ONE WAY SWITCH 16A 250V AC ISI	223.00	8536	20 PCS.	-----
EL-248	2 PIN WALL SOCKET 6A 250V AC	100.00	8536	10 PCS.	-----
EL-220	5 PIN SOCKET 6A 250V AC SHUTTERED	255.00	8536	10 PCS.	140 PCS.



EL-220A EL-221 EL-221A

EL-220A	6A-13A UNIVERSAL SOCKET 250V AC	351.00	8536	10 PCS.	140 PCS.
EL-221	6 PIN SOCKET 6A-16A 250V AC SHUTTERED ISI	382.00	8536	10 PCS.	110 PCS.
EL-221A	6 PIN SOCKET 6A-25A 250V AC SHUTTERED	403.00	8536	10 PCS.	-----

PRODUCTS



EL-222 EL-223 EL-224



EL-225 EL-226 EL-214



EL-230 EL-227A EL-227B



EL-232A EL-232B EL-233A



EL-233B EL-228 EL-237



EL-238 EL-239 EL-229



EL-231 EL-215A EL-245



EL-241 EL-242 EL-215

Cat. No.	DESCRIPTION	LIST PRICE	HSN CODE	BOX/PCS.
EL-222	SCHUKO SOCKET 2 PIN 10A-16A 250V AC	376.00	8536	10 PCS.
EL-223	FLAT PIN ENGLISH SOCKET 13A 250V AC	454.00	8536	10 PCS.
EL-224	SHAVER SOCKET FITTED WITH 5"X3" FRAME	486.00	8536	10 PCS.
EL-225	SHAVER SOCKET 110V/250V WITH SWITCH	437.00	8536	10 PCS.
EL-226	TELEPHONE SOCKET 2 PIN 2A	194.00	8517	20 PCS.
EL-214	NEON INDICATOR	149.00	8531	20 PCS.
EL-230	MEGA NEON INDICATOR	164.00	8531	10 PCS.
EL-227A	SINGLE TELEPHONE LINE JACK 2 WIRE	194.00	8517	20 PCS.
EL-227B	SINGLE TELEPHONE LINE JACK 4 WIRE	212.00	8517	20 PCS.
EL-232A	MEGA TELEPHONE LINE JACK 2 WIRE	207.00	8517	10 PCS.
EL-232B	MEGA TELEPHONE LINE JACK 4 WIRE	227.00	8517	10 PCS.
EL-233A	TWIN TELEPHONE LINE JACK 2 WIRE	327.00	8517	10 PCS.
EL-233B	TWIN TELEPHONE LINE JACK 4 WIRE	360.00	8517	10 PCS.
EL-228	T.V. SOCKET SINGLE OUTLET	190.00	8529	20 PCS.
EL-237	MEGA T.V. SOCKET OUTLET	214.00	8529	10 PCS.
EL-238	TWIN T.V. SOCKET OUTLET	327.00	8529	10 PCS.
EL-239	T.V. SOCKET & TELEPHONE SOCKET	342.00	8529	10 PCS.
EL-229	BLANKING PLATE 1 MODULE	48.00	8529	20 PCS.
EL-231	MEGA BLANKING PLATE	81.00	8538	10 PCS.
EL-215A	FAN REGULATOR 0-4 STEPS SWITCH SIZE 100W HUM FREE	601.00	8414	10 PCS.
EL-245	FAN REGULATOR 0-5 STEPS SOCKET SIZE 100W HUM FREE	699.00	8414	10 PCS.
EL-241	DIMMER 300W AC FOR LIGHT SOCKET SIZE	723.00	8414	10 PCS.
EL-242	DIMMER 500W AC FOR LIGHT SOCKET SIZE	904.00	8414	10 PCS.
EL-215	DIMMER 300W AC FOR LIGHT SWITCH SIZE	591.00	8414	20 PCS.

PRODUCTS



EL-235B EL-235 EL-235A



EL-235D EL-235C EL-246

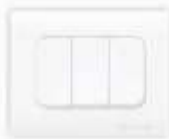

EL-208



EL-243 EL-244



EL-240 EL-134



EL-250 EL-301 EL-303



EL-271

Cat. No.	DESCRIPTION	LIST PRICE	HSN CODE	BOX/PCS.
EL-235B	COMPUTER JACK RJ 45 FOR DATA TRANSFER	912.00	8536	10 PCS.
EL-235	COMPUTER JACK RJ 45 FOR DATA TRANSFER SOCKET SIZE	947.00	8536	10 PCS.
EL-235A	TWIN COMPUTER JACK RJ 45 FOR DATA TRANSFER	1226.00	8536	10 PCS.
EL-235D	COMPUTER JACK RJ 45 FOR DATA TRANSFER CAT. 6	1131.00	8536	10 PCS.
EL-235C	COMPUTER JACK RJ 45 CAT. 6 FOR DATA TRANSFER SOCKET SIZE	1182.00	8536	10 PCS.
EL-246	ELECTRONIC VOLUME CONTROL	552.00	8531	10 PCS.
EL-208	THREE SWITCH TWO WAY 6A 250V AC FITTED 4"X3"	626.00	8536	05 PCS.
EL-243	SWL. SOC. COMBINED 6A 250V AC FITTED 4"X3"	542.00	8536	05 PCS.
EL-244	SWL. SOC. COMBINED 16A 250V AC ISI FITTED 4"X3"	633.00	8536	05 PCS.
EL-240	ELECTRONIC BUZZER 250V AC	465.00	8531	10 PCS.
EL-134	ENERGY SWITCH 20A 250V AC WITH KEY TAG FITTED WITH 3"X3" PLATE	847.00	8536	10 PCS.
EL-250	ELECTRONIC ENERGY KEY SWITCH 16A 250V AC	2045.00	8536	01 PC.
EL-301	SINGLE PHASE MOTOR STARTER 11A/18A	675.00	8536	10 PCS.
EL-303	SINGLE PHASE MOTOR STARTER 25A	712.00	8536	10 PCS.
EL-271	DO NOT DISTURB CLEAN MY ROOM WITH BELL PUSH FITTED WITH 3"X3"	985.00	8536	05 PCS.

PRODUCTS

**ENERGY
KEY TAG**



CAT. NO. KTN-002

**DUAL SUPPLY
KEY TAG**



CAT. No. KTN-001



EL-260



EL-261



EL-262



EL-263



EL-264



EL-265



EL-266



EL-269



EL-267A



EL-268



EL-267



EL-270

Cat. No.	DESCRIPTION	LIST PRICE	HSN CODE	BOX/PCS.
----------	-------------	------------	----------	----------

KTN-002	Electronic Card Switch with time delay 45amp, single phase	2810.00	8536	05 PCS.
---------	--	---------	------	---------

KTN-001	Electronic Card Switch with time delay 45amp, double phase	7710.00	8536	01 PC.
---------	--	---------	------	--------

POLYCARBONATE FRAMES WITH POWER COATED STEEL PLATES

EL-260	CAGE FRAME FOR 1 MODULE 3"X3"	163.00	8538	10 PCS.
--------	-------------------------------	--------	------	---------

EL-261	CAGE FRAME FOR 2 MODULE 4"X3"	184.00	8538	10 PCS.
--------	-------------------------------	--------	------	---------

EL-262	CAGE FRAME FOR 3 MODULE 4"X3"	207.00	8538	10 PCS.
--------	-------------------------------	--------	------	---------

EL-263	CAGE FRAME FOR 4 MODULE 5"X3"	260.00	8538	10 PCS.
--------	-------------------------------	--------	------	---------

EL-264	CAGE FRAME FOR 6 MODULE 8"X3"	332.00	8538	10 PCS.
--------	-------------------------------	--------	------	---------

EL-265	CAGE FRAME FOR 6 MODULE 7"X4"	347.00	8538	10 PCS.
--------	-------------------------------	--------	------	---------

EL-266	CAGE FRAME FOR 8 MODULE 5"X5"	450.00	8538	10 PCS.
--------	-------------------------------	--------	------	---------

EL-269	CAGE FRAME FOR 8 MODULE 5"X6"	437.00	8538	10 PCS.
--------	-------------------------------	--------	------	---------

EL-267A	CAGE FRAME FOR 8 MODULE 9"X3"	426.00	8538	10 PCS.
---------	-------------------------------	--------	------	---------

EL-268	CAGE FRAME FOR 8 MODULE 10"X3"	442.00	8538	10 PCS.
--------	--------------------------------	--------	------	---------

EL-267	CAGE FRAME FOR 12 MODULE 8"X6"	472.00	8538	10 PCS.
--------	--------------------------------	--------	------	---------

EL-270	CAGE FRAME FOR 18 MODULE 8"X8"	532.00	8538	10 PCS.
--------	--------------------------------	--------	------	---------

TECHNICAL PERFORMANCE OF SSK MODULAR SWITCHES

TECHNICAL PERFORMANCE OF SSK MODULAR SWITCHES IN COMPARISON WITH THE REQUIRED SPECIFICATION OF ISI CONFORMING TO IS : 3854 : 1997 (ISI MARK)
(TESTS CONDUCTED AT OUR HIGHLY SOPHISTICATED LAB)

Nature of Test	ISI Requirement	Performance of SSK modular switches tested at our lab
Electric Strength	Should withstand 2KV (rms) for one minute	It withstood 3KV (rms) for 2 minutes
Temperature rise	Should not exceed 45°C (at ambient 35°C) after 40,000 ON-OFF operations on load	It did not increase 14°C after 50,000 operations in 6 Amp accessories and 18°C after 50,000 operations in 16 Amp accessories.
Milli Volt Drop	Should not exceed 20mv (in 6 Amp and 16 Amp accessories) after 40,000 operations on load. MEANWHILE NOT SPECIFIED UNDER NEW SPECIFICATION IS : 3854 : 1997.	Not exceeded 7mv after 1,20,000 ON-OFF operations in 6 Amp and 9mv in 16 Amp. (After this endurance test the products were found in good working conditions.
Insulation Resistance	Should not be less than 100M ohms (Before humidity treatment).	Found more than 500M ohms (after humidity treatment).
Electrical Endurance test (ON-OFF test)	Switches should be tested at 40,000 operations (ON-OFF) on load.	We tested our switches at 1,20,000 operations on load. (Even after this test, switches worked properly).
Mechanical Strength	Specified only at 0.4 Nm impact energy. (Hammer stroke test from a distance of 170mm).	Tested at a maximum impact energy 1 Nm for all rating and designs. (Hammer stroke test from a distance of 270 mm).
Making & breaking Capacity	The switches and sockets are required to be tested at 130% of the rated current and 110% of the rated voltage for 500 continuous operations, with an interval of 30 seconds.	Our switches and sockets were tested at 130% of the rated current and 110% of the rated voltage for 1500 operations and were found to be in good working conditions thereafter.
Resistance to heat at 125°C	The outer body of the moulding should be heated to the temperature of 125°C for 60 minutes. Thereafter the ball pressure test should not make an impression deeper than 2mm.	There was no sign of any impression on the body (insulation material) of our products, after heating at 125°C for 100 minutes.
Resistance to abnormal heat & to fire (Glow wire test)	This test is performed on parts of insulating material, which might be exposed to thermal stress due to electric effects and deterioration shall not unduly be affected by abnormal heat and by fire at a temperature of 650°C	Was not effected by abnormal heat and fire at 850°C.



VIEW OF DIFFERENT PLANTS OF THE COMPANY



SSK
Electrical Excellence
Since 1935

Signature.Nv.
SERIES

PRODUCTS

Cat. No.	DESCRIPTION	LIST PRICE	HSN CODE	BOX/PCS.	CARTON PKG.
NV-100	ONE WAY SWITCH 6A 250V AC	97.00	8536	20 PCS.	400 Pcs.
NV-101	TWO WAY SWITCH 6A 250V AC	188.00	8536	20 PCS.	---
NV-102	BELL PUSH 6A 250V AC	195.00	8536	20 PCS.	---
NV-102A	MEGA BELL PUSH 6A 250V AC	204.00	8536	10 PCS.	---
NV-103	ONE WAY SWITCH 10AX 250V AC WITH PBT BASE	185.00	8536	20 PCS.	---
NV-104	MEGA ONE WAY SWITCH 6A 250V AC	185.00	8536	10 PCS.	---
NV-105	MEGA TWO WAY SWITCH 6A 250V AC	211.00	8536	10 PCS.	---
NV-200	ONE WAY SWITCH 10AX 250V AC	174.00	8536	20 PCS.	---
NV-201	TWO WAY SWITCH 10AX 250V AC	198.00	8536	20 PCS.	---
NV-206	ONE WAY SWITCH 20AX 250V AC	227.00	8536	20 PCS.	---
NV-206A	ONE WAY SWITCH 20AX 250V AC WITH INDICATOR	275.00	8536	20 PCS.	---
NV-207	MEGA ONE WAY SWITCH 20AX 250V AC	245.00	8536	10 PCS.	---
NV-208	MEGA TWO WAY SWITCH 20AX 250V AC	265.00	8536	10 PCS.	---
NV-209	MEGA ONE WAY SP SWITCH 32A 250V AC	404.00	8536	10 PCS.	---
NV-210	MEGA ONE WAY DP SWITCH 32A 250V AC	440.00	8536	10 PCS.	---

NV-100

NV-101

NV-102

NV-102A

NV-103

NV-104

NV-105

NV-200

NV-201

NV-206

NV-206A

NV-207

NV-208

NV-209

NV-210

PRODUCTS

Cat. No. DESCRIPTION LIST PRICE HSN CODE BOX/PCS. CARTON PKG.



NV-211



NV-212



NV-213

NV-211 MEGA ONE WAY DP SWITCH 32A 250V AC WITH INDICATOR

454.00

8536

10 PCS.

NV-212 NEON INDICATOR

153.00

8531

10 PCS.

NV-213 DIMMER 500W AC FOR LIGHT SWITCH SIZE

427.00

8414

10 PCS.



NV-213A



NV-214



NV-215

NV-213A FAN REGULATOR 0-4 STEPS SWITCH SIZE 100W HUM FREE

601.00

8414

05 PCS.

NV-214 FAN REGULATOR 0-5 STEPS SOCKET SIZE 100W HUM FREE

727.00

8414

05 PCS.

NV-215 DIMMER 500W AC FOR LIGHT SOCKET SIZE

626.00

8414

05 PCS.



NV-216



NV-217



NV-218

NV-216 DIMMER 700W AC FOR LIGHT SOCKET SIZE

836.00

8414

10 PCS.

NV-217 2 PIN SOCKET 6A 250V AC

100.00

8536

10 PCS.

NV-218 3 PIN SOCKET 6A 250V AC

202.00

8536

10 PCS.



NV-219



NV-219A



NV-220

NV-219 5 PIN SOCKET 6A 250V AC SHUTTERED

202.00

8536

10 PCS.

140 PCS.

NV-219A 6A-13A UNIVERSAL SOCKET 250V AC

335.00

8536

10 PCS.

140 PCS.

NV-220 6 PIN SOCKET 6A-16A 250V AC SHUTTERED

356.00

8536

10 PCS.

110 PCS.



NV-220A



NV-221



NV-222

NV-220A 6 PIN SOCKET 6A-25A 250V AC SHUTTERED

387.00

8536

10 PCS.

NV-221 3 PIN SOCKET 16A 250V AC

298.00

8536

10 PCS.

NV-222 SHAVER SOCKET WITH SWITCH 110/250V AC

404.00

8536

10 PCS.



NV-223



NV-224



NV-225

NV-223 TELEPHONE SOCKET 2 PIN 2A

198.00

8517

10 PCS.

NV-224 SINGLE TELEPHONE LINE JACK 2 WIRE

198.00

8517

10 PCS.

NV-225 SINGLE TELEPHONE LINE JACK 4 WIRE

221.00

8517

10 PCS.



NV-240



NV-240A



NV-226

NV-240 TWIN TELEPHONE LINE JACK 2 WIRE

259.00

8517

10 PCS.

NV-240A TWIN TELEPHONE LINE JACK 4 WIRE

321.00

8517

10 PCS.

NV-226 T.V. SOCKET SINGLE OUTLET

182.00

8529

10 PCS.



NV-250



NV-227



NV-228

NV-250 ELECTRONIC BUZZER 250V AC

465.00

8531

10 PCS.

NV-227 BLANKING PLATE 1 MODULE

48.00

8538













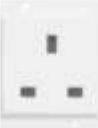

30 PCS.

NV-228 MEGA BLANKING PLATE

82.00

8538

20 PCS.

PRODUCTS		Cat. No.	DESCRIPTION	LIST PRICE	HSN CODE	BOX/PCS.
		NV-229A	COMPUTER JACK RJ 45 FOR DATA TRANSFER CAT. 5 SWITCH SIZE	824.00	8536	10 PCS.
		NV-231	ELECTRONIC VOLUME CONTROL	552.00	8531	10 PCS.
		NV-233	SINGLE PHASE MOTOR STARTER 11A/18A	675.00	8536	05 PCS.
		NV-234	SINGLE PHASE MOTOR STARTER 25A	714.00	8536	05 PCS.
		NV-235	ENERGY SWITCH 30A 250V AC WITH KEY TAG FITTED WITH 3"X3" PLATE	1848.00	8536	05 PCS.
		NV-236	FLAT PIN ENGLISH SOCKET 13A 250V AC	454.00	8536	10 PCS.
		NV-229C	COMPUTER JACK RJ 45 FOR DATA TRANSFER CAT. 6 SOCKET SIZE	1030.00	8536	10 PCS.
		NV-777	ELECTRONIC ENERGY SAVER FOOT LIGHT WITH 5"X3" FRAME	1002.00	8531	05 PCS.
		NV-555	Energy Saver Foot Light 4"x3"	893.00	8531	05 PCS.
		NV-229D	COMPUTER JACK RJ 45 FOR DATA TRANSFER CAT. 6 SWITCH SIZE	985.00	8536	10 PCS.
		NV-246	USB CHARGING PORT 2AMP.	807.00	8536	10 PCS.
		NV-241	MODULAR MCB 16A SP 'C' SERIES	461.00	8536	10 PCS.
		NV-242	MODULAR MCB 25A SP 'C' SERIES	461.00	8536	10 PCS.
		NV-238	DO NOT DISTURB/CLEAN MY ROOM WITH BELL PUSH 6A 250V AC	1004.00	8536	05 PCS.
		NV-243	MODULAR MCB 16A SP 'C' SERIES WITH 16A SOCKET FITTED WITH 4"X3" PLATE	1327.00	8536	05 PCS.
		NV-244	MODULAR MCB 25A SP 'C' SERIES WITH 25A SOCKET FITTED WITH 4"X3" PLATE	1526.00	8536	05 PCS.

PRODUCTS

Cat. No.

DESCRIPTION

LIST PRICE

HSN CODE

BOX/PCS.

POLYCARBOANTE FRAMES WITH POWER COATED STEEL PLATES



NV-260



NV-261

NV-260

CAGE FRAME FOR 1 MODULE 3"X 3"

169.00

8538

10 PCS.

NV-261

CAGE FRAME FOR 2 MODULE 3"X 3"

169.00

8538

10 PCS.



NV-262



NV-263

NV-262

CAGE FRAME FOR 3 MODULE 4"X 3"

198.00

8538

10 PCS.

NV-263

CAGE FRAME FOR 4 MODULE 5"X 3"

248.00

8538

10 PCS.



NV-264K



NV-264A

NV-264K

CAGE FRAME FOR 6 MODULE 7"X 3"

299.00

8538

10 PCS.

NV-264A

CAGE FRAME FOR 6 MODULE 8"X 3"

348.00

8538

10 PCS.



NV-264

NV-264

CAGE FRAME FOR 7 MODULE 8"X 3"

353.00

8538

10 PCS.



NV-265K

NV-265K

CAGE FRAME FOR 8 MODULE 9"X 3"

393.00

8538

10 PCS.



NV-265

NV-265

CAGE FRAME FOR 9 MODULE 10"X 3"

406.00

8538

10 PCS.



NV-266



NV-267

NV-266

CAGE FRAME FOR 8 MODULE 5"X 5"

389.00

8538

10 PCS.

NV-267

CAGE FRAME FOR 8 MODULE 5"X 6"

414.00

8538

05 PCS.



NV-268



NV-269

NV-268

CAGE FRAME FOR 14 MODULE 8"X 6"

555.00

8538

05 PCS.

NV-269

CAGE FRAME FOR 21 MODULE 8"X 8"

652.00

8538

05 PCS.



ACE
Simply beautiful

Dress your wall with luxury
and design.

SSK
Electrical Excellence
Since 1935

PRODUCTS



ACE-100 ACE-101 ACE-102



ACE-102A ACE-104 ACE-107



ACE-206 ACE-206A ACE-207



ACE-208 ACE-209 ACE-210



ACE-211 ACE-212 ACE-213



ACE-213A ACE-214 ACE-215



ACE-216 ACE-217 ACE-218



ACE-219 ACE-219B ACE-219A



ACE-220 ACE-220A ACE-221



ACE-222 ACE-224 ACE-225 ACE-240

Cat. No.	DESCRIPTION	LIST PRICE	HSN CODE	BOX/PCS.	CARTON PKG.
ACE-100	One way switch 10AX 250V AC ISI	62.00	8536	10 PCS.	400 Pcs.
ACE-101	Two way switch 10AX 250V AC ISI	126.00	8536	10 PCS.	----
ACE-102	Bell push 10AX 250V AC ISI	132.00	8536	10 PCS.	----
ACE-102A	Mega bell push 10AX 250V AC ISI	167.00	8536	10 PCS.	----
ACE-104	Mega one way switch 10AX 250V AC ISI	140.00	8536	10 PCS.	----
ACE-107	Intermediate switch	688.00	8536	10 PCS.	----
ACE-206	One way switch 20AX 250V AC ISI	152.00	8536	10 PCS.	----
ACE-206A	One way switch 20AX 250V AC ISI with indicator	177.00	8536	10 PCS.	----
ACE-207	One way switch 20AX 250V AC ISI mega	165.00	8536	10 PCS.	----
ACE-208	Two way switch 20AX 250V AC ISI mega	177.00	8536	10 PCS.	----
ACE-209	Single pole switch 32A 250V AC ISI one way mega	348.00	8536	10 PCS.	----
ACE-210	Double pole switch 32A 250V AC ISI one way mega	412.00	8536	10 PCS.	----
ACE-211	Double pole switch 32A 250V AC ISI one way mega with indicator	442.00	8536	10 PCS.	----
ACE-212	Neon Indicator	96.00	8531	10 PCS.	----
ACE-213	Dimmer 500W ac for light switch size	442.00	8414	10 PCS.	----
ACE-213A	Fan regulator 0-4 steps switch size 100W hum free	481.00	8414	10 PCS.	----
ACE-214	Fan regulator 0-5 steps socket size 100W hum free	622.00	8414	05 PCS.	----
ACE-215	Dimmer 500W AC for light socket size	481.00	8414	05 PCS.	----
ACE-216	Dimmer 700W AC for light socket size	623.00	8414	05 PCS.	----
ACE-217	2 pin socket 6A 250V AC	80.00	8536	10 PCS.	----
ACE-218	3 pin socket 6A 250V AC ISI	141.00	8536	10 PCS.	----
ACE-219	5 pin socket 6A 250V AC shuttered	153.00	8536	10 PCS.	140 PCS.
ACE-219B	5 pin socket 6A 250V AC W/o Shutter	153.00	8536	10 PCS.	140 PCS.
ACE-219A	Universal socket 6A-13A 250V AC	177.00	8536	10 PCS.	140 PCS.
ACE-220	6 pin socket 6A-16A 250V AC shuttered	249.00	8536	10 PCS.	110 PCS.
ACE-220A	6 pin socket 6A-25A 250V AC shuttered	258.00	8536	10 PCS.	110 PCS.
ACE-221	3 pin socket 16A 250V AC ISI	243.00	8536	10 PCS.	----
ACE-222	Shaver socket with switch 110V/250V AC	413.00	8536	10 PCS.	----
ACE-224	Single telephone line Jack 2 wire	117.00	8517	10 PCS.	----
ACE-225	Single telephone line Jack 4 wire	141.00	8517	10 PCS.	----
ACE-240	Twin telephone line Jack 2 wire	198.00	8517	10 PCS.	----

PRODUCTS



ACE-240A ACE-226 ACE-250 ACE-227



ACE-228 ACE-229 ACE-229A



ACE-229D ACE-229C ACE-231



ACE-232 ACE-233 ACE-234



ACE-235 ACE-236



ACE-555 ACE-777



ACE-1063 ACE-1064 ACE-1065



ACE-241 ACE-242



ACE-1066 ACE-1067

Cat. No.	DESCRIPTION	LIST PRICE	HSN CODE	BOX/PCS.
ACE-240A	Twin telephone line jack 4 wire	222.00	8517	10 PCS.
ACE-226	T.V. socket single outlet	126.00	8529	10 PCS.
ACE-250	Electronic buzzer 250V AC	465.00	6531	10 PCS.
ACE-227	Blinking plate one module	33.00	8538	30 PCS.
ACE-228	Mega blinking plate	58.00	8538	20 PCS.
ACE-229	Computer jack RJ 45 for data transfer	900.00	8536	10 PCS.
ACE-229A	Computer jack RJ 45 data transfer switch size	824.00	8536	10 PCS.
ACE-229D	Computer jack RJ 45 for data transfer switch size cat.6	985.00	8536	10 PCS.
ACE-229C	Computer jack RJ 45 for data transfer socket size cat.6	1011.00	8536	10 PCS.
ACE-231	Electronic volume control	552.00	8531	10 PCS.
ACE-232	Fuse 16A/25A 250V AC	174.00	8536	10 PCS.
ACE-233	Single phase motor starter 11A/18A	503.00	8536	05 PCS.
ACE-234	Single phase motor starter 25A	609.00	8536	05 PCS.
ACE-235	Energy switch 30A 250A AC with key tag	1849.00	8536	05 PCS.
ACE-236	Flat pin English socket 13A 250V AC	464.00	8536	10 PCS.
ACE-555	Energy Saver Foot Light 4"x3"	910.00	8531	05 PCS.
ACE-777	Electronic energy saver foot light with 5"x3" cover plate	1021.00	8531	05 PCS.
ACE-1063	DP. switch 20A 250V AC	474.00	8536	10 PCS.
ACE-1064	DP. switch 45A 250V AC	1137.00	8536	10 PCS.
ACE-1065	Key tag 3 module 20A with micro switch & time delay	1877.00	8536	05 PCS.
ACE-241	Modular mcb 16A 5P 'C' series	461.00	8536	10 PCS.
ACE-242	Modular mcb 25A 5P 'C' series	461.00	8536	10 PCS.
ACE-1066	Modular mcb 32A 5P 'C' series	609.00	8536	10 PCS.
ACE-1067	Modular mcb 32A DP 'C' series	953.00	8536	10 PCS.

PRODUCTS



ACE-243 ACE-244



ACE-238



ACE-246



ACE-260 ACE-261



ACE-262 ACE-263



ACE-264



ACE-265



ACE-266



ACE-267 ACE-268



ACE-269



ACE-270

Cat. No.	DESCRIPTION	LIST PRICE	HSN CODE	BOX/PCS.
ACE-243	Modular mcb 16A 3P 'C' series with 6 pin 16A socket fitted with 4"x3" frame	1327.00	8536	05 PCS.
ACE-244	Modular mcb 25A 3P 'C' series with 6 pin 25A socket fitted with 4"x3" frame	1528.00	8536	05 PCS.
ACE-238	Do not disturb/clean my room with bell push 6A 250V AC	1005.00	8536	05 PCS.
ACE-246	Usb charging port 2 Amp.	893.00	8536	10 PCS.
ACE-260	Cover frame for 1 module with powder coated steel plate 3"x3"	128.00	8538	10 PCS.
ACE-261	Cover frame for 2 module with powder coated steel plate 3"x3"	128.00	8538	10 PCS.
ACE-262	Cover frame for 3 module with powder coated steel plate 4"x3"	156.00	8538	10 PCS.
ACE-263	Cover frame for 4 module with powder coated steel plate 5"x3"	178.00	8538	10 PCS.
ACE-264	Cover frame for 6 module with powder coated steel plate 8"x3"	269.00	8538	10 PCS.
ACE-265	Cover frame for 8 module with powder coated steel plate 9"x3"	336.00	8538	10 PCS.
ACE-266	Cover frame for 8 module with powder coated steel plate 10"x3"	373.00	8538	10 PCS.
ACE-267	Cover frame for 8 module with powder coated steel plate 5"x5"	315.00	8538	10 PCS.
ACE-268	Cover frame for 8 module with powder coated steel plate 5"x6"	361.00	8538	05 PCS.
ACE-269	Cover frame for 12 module with powder coated steel plate 8"x6"	418.00	8538	05 PCS.
ACE-270	Cover frame for 18 module with powder coated steel plate 8"x8"	545.00	8538	05 PCS.

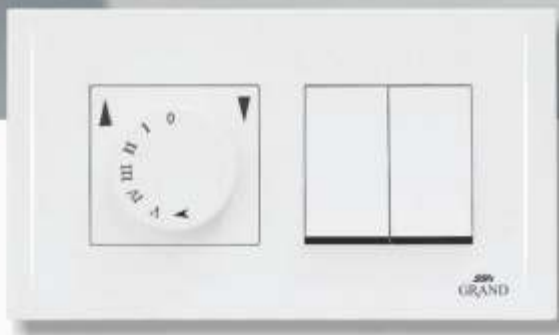

















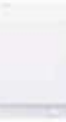







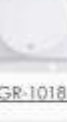

GRAND

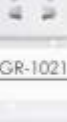
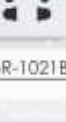
SERIES

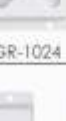
A switch that promises to lineup
to your expectations.

SSK
Electrical Excellence
Since 1935

PRODUCTS			Cat. No.	DESCRIPTION	LIST PRICE	HSN CODE	BOX/PCS.	CARTON PKG.
			GR-1000	One way switch 10AX 250V AC ISI	58.00	8536	20 PCS.	400 Pcs.
			GR-1001	Two way switch 10AX 250V AC ISI	120.00	8536	10 PCS.	---
			GR-1002	Bell push 10AX 250V AC ISI	129.00	8536	10 PCS.	---
			GR-1003	Mega bell push 10AX 250V AC ISI	187.00	8536	10 PCS.	---
			GR-1004	Mega one way switch 10AX 250V AC ISI	133.00	8536	10 PCS.	---
			GR-1005	Intermediate switch	681.00	8536	10 PCS.	---
			GR-1006	One way switch 20AX 250V AC ISI	147.00	8536	10 PCS.	---
			GR-1007	One way switch 20AX 250V AC ISI with indicator	170.00	8536	10 PCS.	---
			GR-1008	One way switch 20ax 250AX 250V AC ISI Mega	173.00	8536	10 PCS.	---
			GR-1009	Two way switch 20AX 250V AC ISI mega	205.00	8536	10 PCS.	---
			GR-1010	Single pole switch 32AX 250V AC ISI one way mega	340.00	8536	10 PCS.	---
			GR-1011	Double pole switch 32AX 250V AC ISI one way mega	404.00	8536	10 PCS.	---
			GR-1012	Double pole switch 32AX 250V AC ISI one way mega with indicator	435.00	8536	10 PCS.	---
			GR-1013	Neon Indicator	87.00	8531	10 PCS.	---
			GR-1014	Dimmer 500W AC for light switch size	428.00	8414	10 PCS.	---
			GR-1015	Fan regulator 0-4 steps switch size 100W hum free	465.00	8414	10 PCS.	---
			GR-1016	Fan regulator 0-5 steps socket size 100W hum free	609.00	8414	05 PCS.	---
			GR-1017	Dimmer 500W AC for light socket size	465.00	8414	05 PCS.	---
			GR-1018	Dimmer 700W AC for light socket size	609.00	8414	05 PCS.	---
			GR-1019	2 pin socket 6A 250V AC	69.00	8536	10 PCS.	---
			GR-1020	3 pin socket 6A 250V AC ISI	129.00	8536	10 PCS.	---
			GR-1021	5 pin socket 6A 250V ac shuttered	141.00	8536	10 PCS.	140 PCS.
			GR-1021B	5 pin socket 6A 250V AC W/o Shutter	141.00	8536	10 PCS.	140 PCS.
			GR-1022	Universal socket 6A-13A 250V AC	165.00	8536	10 PCS.	140 PCS.
			GR-1023	6 pin socket 6A-16A 250V AC shuttered	237.00	8536	10 PCS.	110 PCS.
			GR-1024	6 pin socket 6A-25A 250V AC shuttered	263.00	8536	10 PCS.	110 PCS.
			GR-1025	3 pin socket 16A 250V AC ISI	230.00	8536	10 PCS.	---
			GR-1026	Shaver socket with switch 110V/250V AC	404.00	8536	10 PCS.	---
			GR-1027	Single telephone line jack 2 wire	108.00	8517	10 PCS.	---
			GR-1028	Single telephone line jack 4 wire	132.00	8517	10 PCS.	---
			GR-1029	Twin telephone line jack 2 wire	189.00	8517	10 PCS.	---

PRODUCTS



GR-1030



GR-1031



GR-1032



GR-1033



GR-1034



GR-1035



GR-1036



GR-1037



GR-1038



GR-1039



GR-1040



GR-1041



GR-1042



GR-1043



GR-1044



GR-1065



GR-555



GR-1086



GR-1063



GR-1064



GR-1045



GR-1058



GR-1059

Cat. No.	DESCRIPTION	LIST PRICE	HSN CODE	BOX/PCS.
GR-1030	Twin telephone line jack 4 wire	213.00	8517	10 PCS.
GR-1031	T.V. socket single outlet	139.00	8529	10 PCS.
GR-1032	Blanking plate one module	34.00	8538	30 PCS.
GR-1033	Mega blanking plate	53.00	8538	20 PCS.
GR-1034	Computer jack rj45 cat.5 data transfer	900.00	8536	10 PCS.
GR-1035	Computer jack rj45 for data transfer switch size cat.5	824.00	8536	10 PCS.
GR-1036	Computer jack rj45 for data transfer switch size cat.6	987.00	8536	10 PCS.
GR-1037	Computer jack rj45 for data transfer socket size cat.6	1011.00	8536	10 PCS.
GR-1038	Electronic volume control	552.00	8531	10 PCS.
GR-1039	Fuse 16A/25A 250V AC	174.00	8536	10 PCS.
GR-1040	Single phase motor starter 11A/18A	503.00	8536	05 PCS.
GR-1041	Single phase motor starter 25A	609.00	8536	05 PCS.
GR-1042	Energy switch 30A 250V AC with key tag	1849.00	8536	05 PCS.
GR-1043	Flat pin English socket 13A 250V AC	454.00	8536	10 PCS.
GR-1044	Electronic energy saver foot light with 5"x3" cover plate	1002.00	8531	05 PCS.
GR-1065	Key tag 3 module 20A with micro switch & time delay	1877.00	8536	05 PCS.
GR-555	Energy Saver Foot Light 4"x3"	893.00	8531	05 PCS.
GR-1086	Usb charging port 2 Amp.	893.00	8536	10 PCS.
GR-1063	Dp switch 20A 250V AC	474.00	8536	10 PCS.
GR-1064	Dp switch 45A 250V AC	1137.00	8536	10 PCS.
GR-1045	Do not disturb/clean my room with bell push 6A 250V AC	1033.00	8536	05 PCS.
GR-1058	Modular mcb 16A SP 'C' series	461.00	8536	10 PCS.
GR-1059	Modular mcb 25A SP 'C' series	461.00	8536	10 PCS.

PRODUCTS



GR-1066



GR-1067



GR-1062



GR-1060



GR-1061



GR-1046



GR-1047



GR-1048



GR-1049

FRAME FOR SWITCH & SOCKET



GR-1050



GR-1051



GR-1052



GR-1053



GR-1054



GR-1055



GR-1056



GR-1068



GR-1057

Cat. No.

DESCRIPTION

LIST PRICE

HSN CODE

BOX/PCS.

GR-1066 Modular mcb 32A SP 'C' series 609.00

8536 10 PCS.

GR-1067 Modular mcb 32A DP 'C' series 953.00

8536 10 PCS.

GR-1062 Electronic buzzer 250V AC 465.00

8531 10 PCS.

GR-1060 Modular mcb 16A 5P 'C' series with 6 pin 16A socket fitted with 4"x3" frame 1327.00

8536 05 PCS.

GR-1061 Modular mcb 25A 5P 'C' series with 6 pin 16A socket fitted with 4"x3" frame 1528.00

8536 05 PCS.

GR-1046 Cage frame for 1 module 3"x3" 89.00

8538 10 PCS.

GR-1047 Cage frame for 2 module 3"x3" 89.00

8538 10 PCS.

GR-1048 Cage frame for 3 module 4"x3" 117.00

8538 10 PCS.

GR-1049 Cage frame for switch & socket 4"x3" 117.00

8538 10 PCS.

GR-1050 Cage frame for 4 module 5"x3" 135.00

8538 10 PCS.

GR-1051 Cage frame for 6 module 8"x3" 202.00

8538 10 PCS.

GR-1052 Cage frame for 8 module 9"x3" 220.00

8538 10 PCS.

GR-1053 Cage frame for 8 module 10"x3" 245.00

8538 10 PCS.

GR-1054 Cage frame for 8 module 5"x5" 220.00

8538 10 PCS.

GR-1055 Cage frame for 8 module 5"x6" 250.00

8538 05 PCS.

GR-1056 Cage frame for 12 module 8"x6" 397.00

8538 05 PCS.

GR-1068 Cage frame for 16 module 9"x6" 426.00

8538 05 PCS.

GR-1057 Cage frame for 18 module 8"x8" 476.00

8538 05 PCS.



SSK
Electrical Excellence
Since 1935

Totally safe L.E.D. Illuminating Bell Push can withstand all kinds of weather conditions. Such as Rain, Storms, Hot and extremely cold climate conditions.
Suitable for outside and inside installations.

Illuminating L.E.D. Bell Push

PRODUCTS			Cat. No.	DESCRIPTION	LIST PRICE	HSN CODE	BOX/PCS.
			LED-511SS	1 GANG S. STEEL LED BELL PUSH WITH STAINLESS STEEL TRIM	1434.00	8536	05 PCS.
			LED-511SA	1 GANG S. STEEL LED BELL PUSH WITH METALLIC BLACK TRIM	1434.00	8536	05 PCS.
			LED-511SG	1 GANG S. STEEL LED BELL PUSH WITH STAINLESS STEEL TRIM	1817.00	8536	05 PCS.
			LED-512SS	2 GANG S. STEEL TWIN LED BELL PUSH WITH STAINLESS STEEL TRIM	2868.00	8536	04 PCS.
			LED-512SA	2 GANG S. STEEL TWIN LED BELL PUSH WITH METALLIC BLACK TRIM	2868.00	8536	04 PCS.
			LED-512SG	2 GANG S. STEEL TWIN LED BELL PUSH WITH 24KT GOLD PLATED TRIM	3636.00	8536	04 PCS.
			LED-513SS	3 GANG S. STEEL TRIPLE LED BELL PUSH WITH STAINLESS STEEL TRIM	4303.00	8536	02 PCS.
			LED-513SA	3 GANG S. STEEL TRIPLE LED BELL PUSH WITH METALLIC BLACK TRIM	4303.00	8536	02 PCS.
			LED-513SG	3 GANG S. STEEL TRIPLE LED BELL PUSH WITH 24KT GOLD PLATED TRIM	5452.00	8536	02 PCS.



METALCASE

Bell Push

Features :

- A unique product.
- A life time companion.
- Conforming to International safety standards.
- Beautify your entrance with this highly decorative Bell Push.
- Designed to withstand all kinds of weather conditions.

PRODUCTS



BP-100SS



BP-100AB



BP-100AC



BP-100A



BP-100GL

Cat. No.	DESCRIPTION	LIST PRICE	HSN CODE	BOX/PCS.
BP-100SS	METAL CASE BELL PUSH BRUSHED STAINLESS STEEL FINISH 3"X3"	940.00	8536	05 PCS.
BP-100AB	METAL CASE BELL PUSH ANTIQUE BRASS FINISH 3"X3"	1225.00	8536	05 PCS.
BP-100AC	METAL CASE BELL PUSH ANTIQUE COPPER FINISH 3"X3"	1225.00	8536	05 PCS.
BP-100A	METAL CASE BELL PUSH ANTIQUE FINISH 3"X3"	1225.00	8536	05 PCS.
BP-100GL	METAL CASE BELL PUSH 24KT GOLD PLATED FINISH 3"X3"	2815.00	8536	05 PCS.



TAN BROWN



TOUCH

A TREND SETTING RANGE IN POLYCARBONATE.



PRODUCTS

SWITCHES



TU-601



TU-602



TU-603

SOCKETS



TU-604



TU-605



TU-605A

TWO PIN, TELEPHONE AND T.V. SOCKET



TU-606



TU-607



TU-608

Cat. No.	DESCRIPTION	LIST PRICE		HSN CODE	BOX/PCS.
		White	T. Brown		
TU-601	One way switch 6A 250V AC ISI	37.00	37.00	8536	40 PCS.
TU-602	Two way switch 6A 250V AC ISI	63.00	63.00	8536	40 PCS.
TU-603	Bell push 6A 250V AC ISI	63.00	63.00	8536	40 PCS.
TU-604	Wall socket 3 pin 6A 250V AC	67.00	70.00	8536	20 PCS.
TU-605	Wall socket universal 2/3 pin 6A 250V AC	70.00	70.00	8536	20 PCS.
TU-605A	Wall socket universal 6A-13A 250V AC	187.00	187.00	8536	20 PCS.
TU-606	Wall socket 2 pin 6A 250V AC	72.00	72.00	8536	40 PCS.
TU-607	Telephone line jack two wire switch size	105.00	105.00	8517	40 PCS.
TU-608	T.V. socket Switch size	72.00	75.00	8529	40 PCS.

PRODUCTS

INDICATOR



TU-609

White | T. Brown

Cat. No.	DESCRIPTION	LIST PRICE		HSN CODE	BOX/PCS.
TU-609	Indicator 250V AC	65.00	65.00	8531	40 PCS.

DIMMERS



TU-611



TU-612

TU-611	Dimmer 300W AC for light switch size	402.00	421.00	8414	20 PCS.
TU-612	Dimmer 300W AC for light socket size	459.00	506.00	8414	20 PCS.

REGULATORS



TU-613



TU-614

TU-613	Fan regulator 0-4 steps 100W hum free switch size	513.00	513.00	8414	20 PCS.
TU-614	Fan regulator 0-4 steps 100W hum free socket size	565.00	565.00	8414	20 PCS.

**SP SWITCH WITH INDICATOR
16A 250V AC ISI**



TU-550

**WALL SOCKET UNIVERSAL
6/16A 250V AC**



TU-551

TU-550	SP switch with indicator 16A 250V AC ISI	183.00	183.00	8536	10 PCS.
TU-551	Wall socket universal 6A-16A 250V AC	188.00	188.00	8536	10 PCS.



TU-552



7020A

TU-552	Wall socket combined universal with indicator 6A-16A 250V AC	340.00	340.00	8536	10 PCS.
7020A	Switch socket combined 6A-16A 250V AC universal with box in polycarbonate	377.00	377.00	8536	10 PCS.

PRODUCTS

Cat. No. DESCRIPTION

LIST PRICE

HSN CODE BOX/PCS.

**ONE WAY SWITCH
20AX 250V AC**



TU-615

**ONE WAY SWITCH 20AX
250V AC WITH INDICATOR**



TU-616

**TWO WAY SWITCH
20AX 250V AC**



TU-617

**SP SWITCH 32A
250V AC**

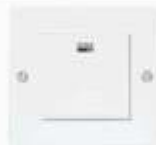

TU-618

**DP SWITCH 32A
250V AC**



TU-619

**D.P. SWITCH 32A 250V AC
WITH INDICATOR**



TU-620

**ONE BELL PUSH
AND INDICATOR**



TU-621

**MEGA BELL PUSH
WITH INDICATOR**



TU-622

**D.P. SWITCH 45A
WITH INDICATOR**



TU-623

**SHAVR SOCKET
110V/240V**



TU-624

**5 PIN SOCKET 6A
250V AC SHUTTERED**



TU-625

**6-13A UNIVERSAL
SOCKET 250V AC**



TU-626

**3 PIN SOCKET
6A 250V AC**



TU-627

**3 PIN SOCKET
16A 250V AC**



TU-628

White | T. Brown

Cat. No.	DESCRIPTION	White	T. Brown	HSN CODE	BOX/PCS.
TU-615	One way switch 20AX 250V AC	209.00	220.00	8536	10 PCS.
TU-616	One way switch 20AX 250V AC with indicator	252.00	265.00	8536	10 PCS.
TU-617	Two way switch 20AX 250V AC	272.00	298.00	8536	10 PCS.
TU-618	Single Pole switch 32A 250V AC one way	388.00	427.00	8536	10 PCS.
TU-619	Double pole switch 32A 250V AC one way	453.00	476.00	8536	10 PCS.
TU-620	Double pole switch 32A 250V AC one way with indicator	491.00	515.00	8536	10 PCS.
TU-621	One bell push 10AX 250V AC with neon indicator	404.00	424.00	8536	10 PCS.
TU-622	Mega bell push with indicator 10AX 250V AC	353.00	388.00	8536	10 PCS.
TU-623	Double pole switch 45A 250V AC one way with indicator	996.00	1045.00	8536	10 PCS.
TU-624	Shaver socket with switch 110V/240V AC	572.00	600.00	8536	10 PCS.
TU-625	5 pin socket 6A 250V AC shuttered	242.00	254.00	8536	10 PCS.
TU-626	6A-13A universal socket 250V AC	354.00	371.00	8536	10 PCS.
TU-627	3 pin socket 6A 250V AC	221.00	232.00	8536	10 PCS.
TU-628	3 pin socket 16A 250V AC	412.00	432.00	8536	10 PCS.

PRODUCTS

Cat. No.

DESCRIPTION

LIST PRICE

HSN CODE

BOX/PCS.

6 PIN SOCKET 6/16A
250V AC SHUTTERED

FLAT PIN ENGLISH
SOCKET 13A 250V AC

White | T. Brown



TU-629



TU-630

TU-629	3 Pin socket 6A-16A 250V AC shuttered	403.00	442.00	8536	10 PCS.
TU-630	Flat pin English socket 13A 250V AC	459.00	482.00	8536	10 PCS.

SINGLE PHASE
STARTER 11A/18A

SINGLE PHASE
STARTER 25A



TU-631



TU-632

TU-631	Single phase motor starter 11A-18A	847.00	930.00	8536	05 PCS.
TU-632	Single phase motor starter 25A	918.00	964.00	8536	05 PCS.

SWITCH SOCKET COMBINED
5 PIN 6A SOCKET WITH 10AX SWITCH

SWITCH SOCKET COMBINED
6 PIN 6/16A SOCKET WITH 20AX SWITCH



TU-633

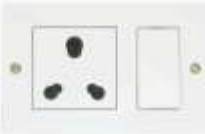

TU-634

TU-633	Switch socket combined 5 pin socket 6A 250V AC shuttered with 10ax switch 250V AC	353.00	370.00	8536	05 PCS.
TU-634	Switch socket combined 6 pin socket 6A-16A 250V AC shuttered with 20AX 250V AC	606.00	636.00	8536	05 PCS.

SWITCH SOCKET COMBINED
6 PIN 6A-16A SOCKET WITH 20AX SWITCH

SWITCH SOCKET COMBINED
6/13A UNIVERSAL SOCKET WITH 20AX SWITCH



TU-635



TU-636

TU-635	Switch socket combined 6 pin socket 6A-16A 250VAC shuttered with 20AX switch 250V AC with indicator	651.00	683.00	8536	05 PCS.
TU-636	Switch socket combined universal socket 6A-13A pin socket 6A-16A 250V AC shuttered with 20AX switch 250VAC	569.00	598.00	8536	05 PCS.

SWITCH SOCKET COMBINED
FLAT PIN ENGLISH SOCKET WITH 20AX SWITCH

SWITCH SOCKET COMBINED
6 PIN 6/16A SOCKET WITH 20AX SWITCH



TU-637



TU-638

TU-637	Switch socket combined british socket 13A 250V AC with 20AX 250V AC	772.00	811.00	8536	05 PCS.
TU-638	One way switch 20ax 250v ac with 6 pin socket 6A-16A 250V AC shuttered	750.00	788.00	8536	05 PCS.

6 PIN 6/16A SOCKET SHUTTERED WITH
11A/18A SINGLE PHASE MOTOR STARTER

6 PIN 6/16A SOCKET SHUTTERED WITH
25A SINGLE PHASE MOTOR STARTER



TU-639



TU-640

TU-639	Single phase motor starter 11A-18A with 6 pin socket 6A-16A 250V AC shuttered	1277.00	1341.00	8536	05 PCS.
TU-640	Single phase motor starter 25A with 6 pin socket 6A-16A 250V AC shuttered	1320.00	1386.00	8536	05 PCS.

16A SOCKET WITH 20AX SWITCH
COMBINED AND 16A 250V AC

10AX SWITCH AND
6A SOCKET COMBINED



TU-641



TU-643

TU-641	Switch socket combined 6A-16A socket 250V AC shuttered with use 16A-25A and 20AX switch	860.00	903.00	8536	05 PCS.
TU-643	Switch socket combined 3 pin 6A socket 250V AC with 10AX switch 250V AC	267.00	268.00	8536	05 PCS.



SSK
Electrical Excellence
Since 1935



topline
SERIES

PRODUCTS

Cat. No. DESCRIPTION LIST PRICE HSN CODE BOX/PCS.

Switches 6A In Polycarbonate



501 502 503

White | T. Brown

Cat. No.	DESCRIPTION	White	T. Brown	HSN CODE	BOX/PCS.
501	One way switch 6A 250V AC ISI	37.00	37.00	8536	40 PCS.
502	Two way switch 6A 250V AC ISI	63.00	63.00	8536	40 PCS.
503	Bell push 6A 250V AC ISI	63.00	63.00	8536	40 PCS.

Sockets 6A In Polycarbonate



504 505 505A

504	Wall socket 3 pin 6A 250V AC	70.00	70.00	8536	20 PCS.
505	Wall socket universal 2/3 pin 6A 250V AC	70.00	70.00	8536	20 PCS.
505A	Wall socket universal 6A-13A 250V AC	187.00	187.00	8536	20 PCS.

2 PIN SOCKET AND 16A SP/DP SWITCHES



555 550 SP 552 DP

555	Wall socket 2 pin 6A 250V AC	72.00	72.00	8536	40 PCS.
550 SP	Switch SP with indicator 16A 250V AC ISI	183.00	183.00	8536	10 PCS.
552 DP	Switch DP with indicator 16A 250V AC ISI	238.00	238.00	8536	10 PCS.

PRODUCTS

Cat. No.	DESCRIPTION	LIST PRICE	HSN CODE	BOX/PCS.
----------	-------------	------------	----------	----------

16A 2WAY SWITCH AND 16A SOCKET



553

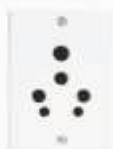

551

White | T. Brown

553	Switch two way 16A 250V AC ISI	228.00	228.00	8536	10 PCS.
551	Wall Socket Universal 6-16A 250V AC	188.00	188.00	8536	10 PCS.

Switch Socket combined In Polycarbonate



592

592	Switch socket combined 6A-16A 250V ac universal with indicator	340.00	340.00	8536	10 PCS.
-----	--	--------	--------	------	---------

Indicator and Fuse In Polycarbonate



506

506	Indicator 250V ac in pc	65.00	65.00	8531	40 PCS.
-----	-------------------------	-------	-------	------	---------

T.V. Antenna Outlet and Telephone Socket



563



564

563	T.V. connector switch size in pc.	75.00	75.00	8529	40 PCS.
564	Telephone line Jack switch size in pc	100.00	105.00	8517	40 PCS.

Dimmers In Polycarbonate



515



561

515	Dimmer 300W AC switch size with LED for light	402.00	421.00	8414	20 PCS.
561	Dimmer 300W AC socket size with LED. for light	459.00	506.00	8414	20 PCS.

Regulators In Polycarbonate



580



581

580	Fan regulator 0-4 steps 100W hum free socket size in pc.	565.00	565.00	8414	20 PCS.
581	Fan regulator 0-4 steps 100W hum free switch size in pc	513.00	513.00	8414	20 PCS.



topline
Dimple

PRODUCTS

Switches 6A In Polycarbonate



511



512



513

Sockets 6A In Polycarbonate



504



505



505A

2 PIN SOCKET AND 16A SP/DP SWITCHES



555



550 SP



552 DP

Cat. No.	DESCRIPTION	LIST PRICE		HSN CODE	BOX/PCS.
----------	-------------	------------	--	----------	----------

White | T. Brown

511	One way switch 6A 250V AC ISI	37.00	37.00	8536	40 PCS.
512	Two way switch 6A 250V AC ISI	63.00	63.00	8536	40 PCS.
513	Bell push 6A 250V AC ISI	63.00	63.00	8536	40 PCS.

504	Wall socket 3 pin 6A 250V AC	70.00	70.00	8536	20 PCS.
505	Wall socket universal 2/3 pin 6A 250V AC	70.00	70.00	8536	20 PCS.
505A	Wall socket universal 6A-13A 250V AC	187.00	187.00	8536	20 PCS.

555	Wall socket 2 pin 6A 250V AC	72.00	72.00	8536	40 PCS.
550 SP	Switch SP with indicator 16A 250V AC ISI	183.00	183.00	8536	10 PCS.
552 DP	Switch DP with indicator 16A 250V AC ISI	228.00	238.00	8536	10 PCS.

PRODUCTS

Cat. No.

DESCRIPTION

LIST PRICE

HSN CODE

BOX/PCS.

16A 2WAY SWITCH AND 16A SOCKET

White | T. Brown



553

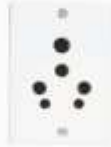

551

553	Switch two way 16A 250V AC ISI	228.00	228.00	8536	10 PCS.
551	Wall Socket Universal 6-16A 250V AC	188.00	188.00	8536	10 PCS.

Switch Socket combined In Polycarbonate



592

592	Switch socket combined 6A-16A 250V ac universal with indicator	340.00	340.00	8536	10 PCS.
-----	--	--------	--------	------	---------

Indicator and Fuse In Polycarbonate



506

506	Indicator 250V ac in pc	65.00	65.00	8531	40 PCS.
-----	-------------------------	-------	-------	------	---------

T.V. Antenna Outlet and Telephone Socket



563



564

563	T.V. connector switch size in pc.	72.00	75.00	8529	40 PCS.
564	Telephone line jack switch size in pc	105.00	105.00	8517	40 PCS.

Dimmers in Polycarbonate



515



561

515	Dimmer 300W AC switch size with LED for light	402.00	421.00	8414	20 PCS.
561	Dimmer 300W AC socket size with LED, for light	459.00	506.00	8414	20 PCS.

Regulators In Polycarbonate



580



581

580	Fan regulator 0-4 steps 100W hum free socket size in pc.	565.00	565.00	8414	20 PCS.
581	Fan regulator 0-4 steps 100W hum free switch size in pc	513.00	513.00	8414	20 PCS.



PRODUCTS

Cat. No.	DESCRIPTION	LIST PRICE	HSN CODE	BOX/PCS.
----------	-------------	------------	----------	----------

6A SWITCHES AND BELL PUSH SWITCH



F-900



F-901



F-902

F-900	One way switch 6A 250V AC ISI	51.00	8536	40 PCS.
F-901	Two way switch 6A 250V AC ISI	70.00	8536	20 PCS.
F-902	Bell push 6A 250V AC ISI	70.00	8536	20 PCS.

16A SWITCHES



F-954



F-950



F-952

F-954	5P switch mini 16A 250V AC ISI	198.00	8536	20 PCS.
F-950	Mega SP switch with indicator 16A 250V AC ISI	238.00	8536	10 PCS.
F-952	Mega DP switch with indicator 16A 250V AC ISI	311.00	8536	10 PCS.

SWITCH 16A, 32A AND MEGA BELL PUSH



F-953



F-957



F-955

F-953	Switch two way 16A 250V AC ISI	307.00	8536	10 PCS.
F-957	Switch DP 32A 250V AC with indicator	359.00	8536	10 PCS.
F-955	Bell Push 6A 250V AC ISI socket size with indicator	131.00	8536	10 PCS.

PRODUCTS

WALL SOCKETS 6A AND 16A



F-904

F-904B

F-951

Cat. No.	DESCRIPTION	LIST PRICE	HSN CODE	BOX/PCS.
F-904	Socket 5 pin shuttered 6A 250V AC	117.00	8536	20 PCS.
F-904B	Socket 3 pin 6A 250V AC	113.00	8536	20 PCS.
F-951	Socket universal 6A-16A 250V AC shuttered	217.00	8536	10 PCS.

REGULATORS AND DIMMER



F-911

F-912A

F-912

F-911	Fan regulator socket size 0-4 steps 100W hum free	690.00	8414	10 PCS.
F-912A	Fan regulator switch size 0-4 steps 100W hum free	575.00	8414	10 PCS.
F-912	Dimmer 300W for light	509.00	8414	20 PCS.

TELEPHONE JACKS AND SOCKET



F-907

F-908

F-909

F-907	Single telephone line jack 2 wire	118.00	8517	20 PCS.
F-908	Single telephone line jack 4 wire	140.00	8517	20 PCS.
F-909	Telephone socket 2 pin 2A	100.00	8517	20 PCS.

FUSE, INDICATOR AND 2 PIN SOCKET



F-903

F-905

F-903	Neon indicator 250V AC	70.00	8531	20 PCS.
F-905	2 pin socket 6A 250V AC	84.00	8536	20 PCS.

T.V. SOCKET AND DUMMY PLATES



F-906

F-924

F-925

F-906	T.V. socket single outlet	108.00	8529	20 PCS.
F-924	1 module blanking plate	30.00	8538	40 PCS.
F-925	2 module blanking plate	39.00	8538	20 PCS.

INSERTS



F-919

F-920

F-919	Switch size insert (White-colour)	18.00	8538	40 PCS.
F-920	Socket size insert (White-colour)	23.00	8538	20 PCS.

Fantasy plus



Affordable Modular Fantasy Plus Range
Fits on standard steel boxes.



Fantasy plus

PRODUCTS

Cat. No.

DESCRIPTION

LIST PRICE

HSN CODE

BOX/PCS.



FP-001

FP-002

FP-001 Frame for 1 module suitable 3"x3" 160.00

160.00

8538

10 PCS.

FP-002 Frame for 2 module suitable 3"x3" 160.00

160.00

8538

10 PCS.



FP-003

FP-004

FP-003 Frame for motor starter suitable 3"x3" 167.00

167.00

8538

10 PCS.

FP-004 Frame for 3 module suitable 4"x3" 189.00

189.00

8538

10 PCS.



FP-005

FP-006

FP-005 Frame 4 module suitable 5"x3" 231.00

231.00

8538

10 PCS.

FP-006 Frame for motor starter and 16a socket suitable for 5"x3" 231.00

231.00

8538

10 PCS.



FP-007

FP-008

FP-007 Frame for 8 module suitable 5"x5" 451.00

451.00

8538

10 PCS.

FP-008 Frame for 8 module suitable 6"x5" 486.00

486.00

8538

10 PCS.

PRODUCTS

Cat. No.

DESCRIPTION

LIST PRICE

HSN CODE

BOX/PCS.



FP-009

FP-009

Frame for 7 module suitable 8"x3"

332.00

8538

10 PCS.



FP-013

FP-013

Frame for 8 module suitable 9"x3"

439.00

8538

10 PCS.



FP-010

FP-010

Frame for 9 module suitable 10"x3"

505.00

8538

10 PCS.

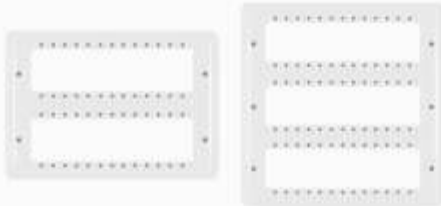

FP-011

FP-012

FP-011

Frame for 14 module suitable 8"x6"

568.00

8538

10 PCS.

FP-012

Frame for 18 module suitable 8"x8"

750.00

8538

10 PCS.



FPA-001

FPA-002

FPA-003

FPA-001

Single phase motor starter 11A-18A fitted with 3"x3"

1398.00

8538

10 PCS.

FPA-002

Single phase motor starter 11A-18A and socket 6A-16A 250v ac shuttered fitted with 3"x3"

1825.00

8538

10 PCS.

FPA-003

Energy switch 30A 250V AC with key tag

2318.00

8538

05 PCS.

Please specify colour codes in your order.



GLW

GLK

GL

GL	Gold
GLK	Gold Black
GLW	Gold White

R	Red
RK	Red Black
RW	Red White



RW

RK

R



BW

BK

B

B	Blue
BK	Blue Black
BW	Blue White

S	Silver
SK	Silver Black
SW	Silver White



SW

SK

S



GW

GK

G

G	Green
GK	Green Black
GW	Green White

GR	Grey
GRK	Grey Black
GRW	Grey White



GRW

GRK

GR

SWITCH SIZE (F-919)
LIST PRICE 26.00

COLOURED
FRAMES

SOCKET SIZE (F-920)
LIST PRICE 30.00



With Spike Guard

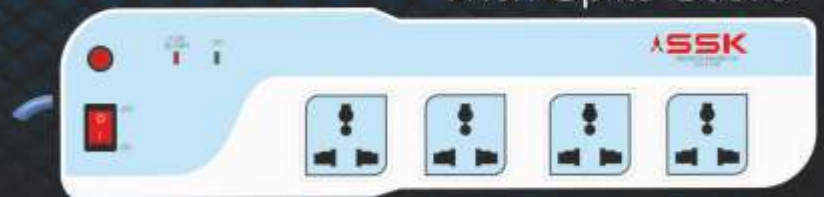

PRODUCTS

Cat. No. DESCRIPTION LIST PRICE HSN CODE BOX/PCS.

BATTEN HOLDERS IN POLYCARBONATE

With Metal Ring



171

571

76

White | T. Brown

Cat. No.	DESCRIPTION	White	T. Brown	HSN CODE	BOX/PCS.
171	Jumbo batten holder	79.00	91.00	8536	10 PCS.
571	Jumbo batten holder 2A 250V AC with jumbo skirt	85.00	87.00	8536	10 PCS.
76	Batten holder 2A250V AC with skirt	71.00	78.00	8536	20 PCS.

BATTEN AND ANGLE HOLDER IN POLYCARBONATE

With Metal Ring



576

79

579

576	Batten lamp holder 2A 250V AC with jumbo skirt	81.00	84.00	8536	20 PCS.
79	Angle lamp holder 2A 250V AC	75.00	83.00	8536	20 PCS.
579	Angle lamp holder 2A 250V AC with jumbo skirt	81.00	84.00	8536	20 PCS.

BATTEN HOLDERS IN POLYCARBONATE

With Metal Ring



PC-577

PC-577A

PC-577	Batten holder with interlock 2A 250V AC	82.00	88.00	8536	20 PCS.
PC-577A	Jumbo batten holder with interlocked designer cap 2A	91.00	103.00	8536	20 PCS.



MBH-577

MAH-577

MBH-577	Modular Batten Holder 2A 250V AC ring type	120.00	-----	8536	10 PCS.
MAH-577	Modular Angle Holder 2A 250V AC ring type	120.00	-----	8536	10 PCS.

PANDENT HOLDERS



74A

In Phenolic
Formaldehyde

Available in black colour

74A	Pendent holder 2A 250V AC ring type	-----	63.00	8536	30 PCS.
-----	-------------------------------------	-------	-------	------	---------

PRODUCTS

Cat. No.

DESCRIPTION

LIST PRICE

HSN CODE

BOX/PCS.

CEILING ROSES IN POLYCARBONATE



128



129



572

White | T. Brown

White	T. Brown	HSN CODE	BOX/PCS.
63.00	69.00	8534	20 PCS.
66.00	69.00	8534	20 PCS.
91.00	95.00	8534	10 PCS.

New



160B

320.00	-----	8534	10 PCS.
--------	-------	------	---------

32A D.P. SWITCHES



160



160A

370.00	-----	8536	20 PCS.
331.00	-----	8536	20 PCS.

MULTI SOCKET ADAPTOR IN POLYCARBONATE



PC-999



299.00	-----	8536	20 PCS.
--------	-------	------	---------



MSA-999



TUA-999

127.00	-----	8536	10 PCS.
242.00	-----	8536	10 PCS.

PRODUCTS

Cat. No.

DESCRIPTION

LIST PRICE

HSN CODE

BOX/PCS.



DP-32AS

DP-32AS Surface type DP MCB with enclosure & indicator 32A

635.00

8536

05 PCS.



PSM-1501

PSM-1501 Power plug socket with mcb protection 4m 25Amp. with box 5"X3" fitted

1181.00

8536

01 PC.

ELECTRONIC DOOR BELLS



B-5001



B-5002

B-5001 Electronic door bell bulbul, Islamic, church, ding dong, waheguru, multi tones, gayatri mantra

501.00

8531

01 PC.

B-5002 Electronic door bell bulbul

495.00

8531

01 PC.



SSKPB-1001

SSKPB-1001 Heavy Duty Extension board With 4 Universal Sockets 6A, with 3 Meter Cord

797.00

8536

01 PC.



SPG-1002

SPG-1002 Heavy duty spike guard with 4 universal sockets 6A, with on-off switch and 3 meter long lead

1107.00

8536

01 PC.



SSKPB-1003

SSKPB-1003 Heavy Duty Extension board With 4 Sockets 16A and 1 Switch 16A with 3 meter long lead

3870.00

8536

01 PC.

PRODUCTS

16A SWITCH AND SOCKET



95 N

61 N

Cat. No.	DESCRIPTION	LIST PRICE	HSN CODE	BOX/PCS.
----------	-------------	------------	----------	----------

95 N	DP Switch 20AX 250V AC in polycarbonate and glass filled pbt kay/s	362.00	8536	10 PCS.
------	--	--------	------	---------

61 N	6 Pin wall socket 16A250V AC in polycarbonate and glass filled pbt kay/s	310.00	8536	10 PCS.
------	--	--------	------	---------

TUMBLER TYPE SWITCHES 6A



159

8

22

159	SP Switch 6A 250V AC black ISI/duro k/555	160.00	8536	20 PCS.
-----	---	--------	------	---------

8	SP Switch round 6A 250V AC porcelain base ISI kay/s	173.00	8536	20 PCS.
---	---	--------	------	---------

22	Switch two way 6A 250V AC black ISI k/555	184.00	8536	20 PCS.
----	---	--------	------	---------

2 PIN WALL SOCKET



55

55	2 Pin wall socket 6A 250V AC black k/555	86.00	8536	36 PCS.
----	--	-------	------	---------

6A SOCKETS AND SWITCH SOCKET COMBINED



57

59

46

57	3 Pin wall socket 6A 250V AC black kay/s	113.00	8536	10 PCS.
----	--	--------	------	---------

59	3 Pin wall socket 6A 250V AC with porcelain base kay/s	124.00	8536	10 PCS.
----	--	--------	------	---------

46	Switch socket combined 6A 250V AC 3 pin black kay/s	260.00	8536	06 PCS.
----	---	--------	------	---------

PLUGS 6A AND 16A



EL-607

EL-608

EL-607	3 Pin Plug Top 6A 250V AC Without Indicator	76.00	8536	10 PCS.
--------	---	-------	------	---------

EL-608	3 Pin Plug Top 16A 250V AC without Indicator	140.00	8536	10 PCS.
--------	--	--------	------	---------



EL-609

EL-609	2 Pin Plug 6A 250V AC	35.00	8536	10 PCS.
--------	-----------------------	-------	------	---------



EL-610

EL-610	Male Female 2 Pin 6A 250V AC	70.00	8536	10 PCS.
--------	------------------------------	-------	------	---------

PRODUCTS

Cat. No.

DESCRIPTION

LIST PRICE

HSN CODE

BOX/PCS.

PLUGS IN POLYCARBONATE

White | T. Brown



143

143	3 Pin Plug 6A 250V AC in PC	138.00	145.00	8536	20 PCS.
-----	-----------------------------	--------	--------	------	---------



EL-604



EL-605

EL-604	3 Pin plug triangular with indicator 6A 250V AC	147.00	-----	8536	10 PCS.
--------	---	--------	-------	------	---------

EL-605	3 Pin plug triangular with indicator 16A 250V AC	278.00	-----	8536	10 PCS.
--------	--	--------	-------	------	---------



EL-604A



EL-605A

EL-604A	3 Pin plug triangular 6A 250V AC	138.00	-----	8536	10 PCS.
---------	----------------------------------	--------	-------	------	---------

EL-605A	3 Pin plug triangular 16A 250V AC	268.00	-----	8536	10 PCS.
---------	-----------------------------------	--------	-------	------	---------



EL-606



EL-606A

EL-606	3 Pin plug triangular 25A 250V AC	225.00	-----	8536	10 PCS.
--------	-----------------------------------	--------	-------	------	---------

EL-606A	3 Pin plug triangular 25A 250V AC	275.00	-----	8536	10 PCS.
---------	-----------------------------------	--------	-------	------	---------



53

Available in
Only Black Colour

53	3 Pin plug 16A 250V AC push type	-----	328.00	8536	06 PCS.
----	----------------------------------	-------	--------	------	---------

ROUND PLATE



88

88	Round Plate in polycarbonate	39.00	-----	8536	50 PCS.
----	------------------------------	-------	-------	------	---------

WHY SSK WIRE IS BETTER ?



Heat Temperature Resistant
(Flame Retardant Cables)



High Grade Electrolytic
Copper



High Insulation Resistance



ROHS Compliant Approved



More Than 99% Copper
Conductivity

FEATURES :

- Flame Retardant
- ETP Copper & Maximum Conductivity
- We use High Grade PVC for Better Quality



FR
Wires & Cables
For Better Conductivity

SINGLE CORE, FLAME RETARDANT (FR) UNSHEATHED CABLES WITH FLEXIBLE CONDUCTOR
- VOLTAGE GRADE 1100V, CONFORMING TO IS 694:2010

Single Core Heat Resistant Cable



Nominal Area of Conductor	Number / Nominal Dia of Wire	Thickness of Insulation (Nom.)	Approx. Overall diameter	Current Carrying capacity 2 cable, Single Phase In Conduit/ Truncking Amps.	Resistance (max) per Km @ 20C Ohms.	Standard Packing (90 Meters)
Sq. mm	mm	mm	mm			
0.75	24/0.2*	0.6	2.8	7	26.00	20
1.0	14/0.3*	0.6	3.0	12	18.10	20
1.5	22/0.3*	0.7	3.4	16	12.10	16
2.5	36/0.3*	0.8	4.1	22	7.41	12
4.0	56/0.3*	0.8	4.8	29	4.95	4
6.0	84/0.3*	0.8	5.3	32	3.20	4
10	140/0.3*	1.0	7.0	42	1.90	1
16	126/0.4*	1.2	9.7	57	1.21	1

COLOUR CODES :





Electrical Excellence
Since 1935



- » Row Type MCB Db's (Double Door)
- » SPN, TPN MCB Db's (Double Door)
- » MCB's (SP, DP, TP AND FP)
- » ISOLATORS



New Range of Distribution Boards WITH POLYCARBONATE TRIMS

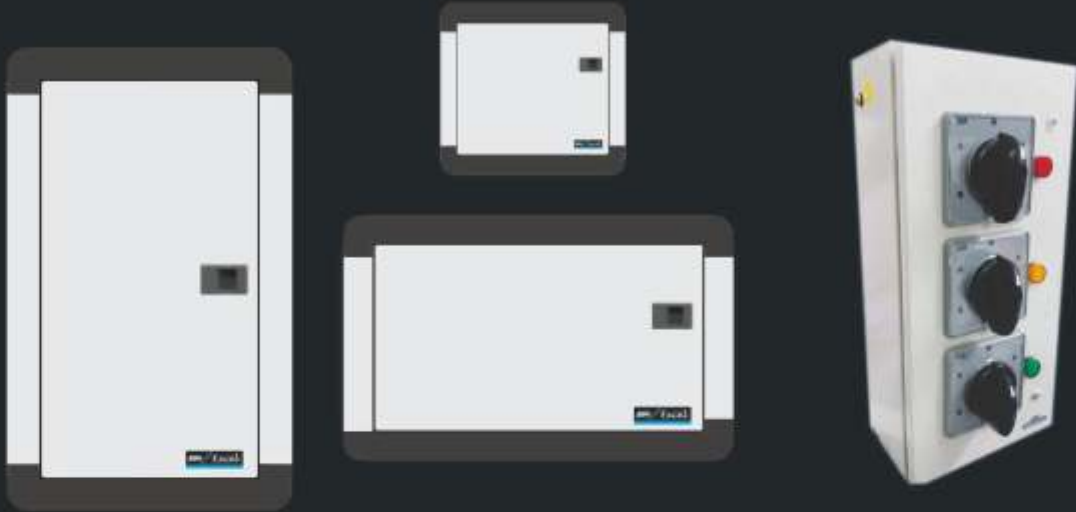

Distribution boards are manufactured out of high quality steel sheets and are processed on CNC machines. Each box goes through the 7 tank process of phosphating before they are powder coated in the best possible environment giving the finest finish.

Products referring to IS : 13032 & IEC : 439 & 529.

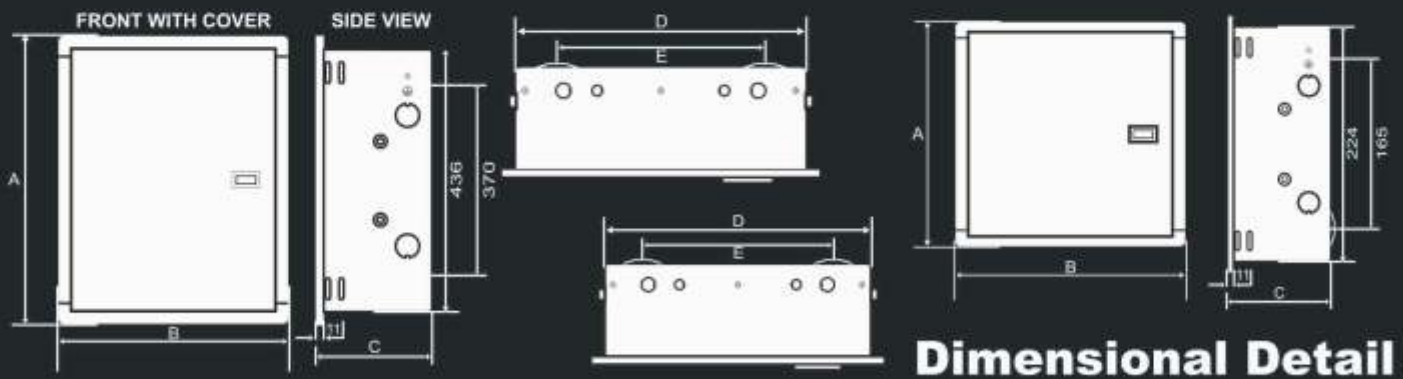

Dimensional Detail

TPN DB DOUBLE DOOR								SPN DB DOUBLE DOOR							
No. of WAYS	A	B	C	D	E	KNOCKOUTS		No. of WAYS	A	B	C	D	E	KNOCKOUTS	
						INCOMING	OUTGOING							INCOMING	OUTGOING
4 WAY	450	268	98	252	195	4XØ 31.5	4XØ 31.5	4 WAY	244	196	88	175	125	3XØ 25.5	3XØ 25.5
6 WAY	450	340	98	325	268	6XØ 31.5	6XØ 31.5	6 WAY	244	196	88	175	125	3XØ 25.5	3XØ 25.5
8 WAY	450	412	98	396	340	6XØ 31.5	4XØ 31.5	8 WAY	244	268	88	246	187	2XØ 25.5	2XØ 31.5
								10 WAY	244	268	88	246	187	2XØ 25.5	2XØ 31.5
								12 WAY	244	340	88	318	258	4XØ 25.5	4XØ 25.5
								16 WAY	244	412	88	390	340	4XØ 31.5	2XØ 31.5

	No. OF WAYS	TYPE	CAT. No.	LIST PRICE	HSN CODE
	ROW TYPE MCB DISTRIBUTION BOARDS (DOUBLE DOOR)				
	16 WAY	1 ROW X 16 SP	860	3906.00	8536
	32 WAY	2 ROW X 16 SP	861	5555.00	8536
	48 WAY	3 ROW X 16 SP	862	7025.00	8536
	64 WAY	4 ROW X 16 SP	863	8365.00	8536
	80 WAY	5 ROW X 16 SP	864	9477.00	8536
	SPN MCB DISTRIBUTION BOARDS (DOUBLE DOOR)				
	4 WAY	DOUBLE DOOR	852DD	1664.00	8536
	6 WAY	DOUBLE DOOR	853DD	1786.00	8536
	8 WAY	DOUBLE DOOR	854DD	2187.00	8536
	10 WAY	DOUBLE DOOR	865DD	2283.00	8536
	12 WAY	DOUBLE DOOR	866DD	2886.00	8536
	16 WAY	DOUBLE DOOR	866DDA	3714.00	8536
	TPN MCB DISTRIBUTION BOARDS (DOUBLE DOOR)				
	4 WAY	DOUBLE DOOR DX	855	ON REQUEST	8536
	6 WAY	DOUBLE DOOR DX	856	ON REQUEST	8536
	8 WAY	DOUBLE DOOR DX	857	ON REQUEST	8536
	4 WAY	DOUBLE DOOR	867	4374.00	8536
	6 WAY	DOUBLE DOOR	868	5593.00	8536
	8 WAY	DOUBLE DOOR	869	7104.00	8536
	10 WAY	DOUBLE DOOR	870	8252.00	8536
	12 WAY	DOUBLE DOOR	871	9907.00	8536
	SPN MCB DISTRIBUTION BOARDS (DOUBLE DOOR WITH GLASS)				
	4 WAY	DOUBLE DOOR	852DDG	1825.00	8536
	6 WAY	DOUBLE DOOR	853DDG	1905.00	8536
	8 WAY	DOUBLE DOOR	854DDG	2369.00	8536
	10 WAY	DOUBLE DOOR	865DDG	2506.00	8536
	12 WAY	DOUBLE DOOR	866DDG	3074.00	8536
	16 WAY	DOUBLE DOOR	866DDGA	3986.00	8536
	TPN MCB DISTRIBUTION BOARDS (DOUBLE DOOR WITH GLASS)				
	4 WAY	DOUBLE DOOR DX	855G	ON REQUEST	8536
	6 WAY	DOUBLE DOOR DX	856G	ON REQUEST	8536
	8 WAY	DOUBLE DOOR DX	857G	ON REQUEST	8536
	4 WAY	DOUBLE DOOR	867G	4717.00	8536
	6 WAY	DOUBLE DOOR	868G	5963.00	8536
	8 WAY	DOUBLE DOOR	869G	7637.00	8536
	10 WAY	DOUBLE DOOR	870G	8753.00	8536
	12 WAY	DOUBLE DOOR	871G	10,900.00	8536
	SPN MCB DISTRIBUTION BOARDS (SINGLE DOOR)				
	4 WAY	SINGLE DOOR	852	918.00	8536
	6 WAY	SINGLE DOOR	853	1026.00	8536
	8 WAY	SINGLE DOOR	854	1156.00	8536
	10 WAY	SINGLE DOOR	865	1278.00	8536
	12 WAY	SINGLE DOOR	866	1571.00	8536
	16 WAY	SINGLE DOOR	866A	1944.00	8536

New Range of Distribution Boards (WITH POLYCARBONATE TRIMS)

No. OF WAYS	TYPE	CAT. No.	LIST PRICE	HSN CODE
-------------	------	----------	------------	----------



TPN MCB DISTRIBUTION BOARDS (SINGLE DOOR)

4 WAY	SINGLE DOOR	855A	3881.00	8536
6 WAY	SINGLE DOOR	856A	4445.00	8536
8 WAY	SINGLE DOOR	857A	5109.00	8536
10 WAY	SINGLE DOOR	858A	5683.00	8536
12 WAY	SINGLE DOOR	859A	6438.00	8536

TPN MCB DISTRIBUTION BOARDS (SLIMLINE - SINGLE DOOR)



4 WAY	SINGLE DOOR	855SL	3043.00	8536
6 WAY	SINGLE DOOR	856SL	3649.00	8536
8 WAY	SINGLE DOOR	857SL	4075.00	8536
10 WAY	SINGLE DOOR	858SL	4584.00	8536
12 WAY	SINGLE DOOR	859SL	5348.00	8536

PHASE SELECTOR UNIT PRICES ARE WITHOUT MCB's.

No. OF WAYS	INCOMERS + OUTGOING	CAT. No.	LIST PRICE	HSN CODE
-------------	---------------------	----------	------------	----------



PHASE SELECTOR DISTRIBUTION BOARDS

4 (40A)	6 + 12	SPS 855 DD	17,174.00	8536
4 (63A)	6 + 12	SPS 855 DDA	19,059.00	8536
6 (40A)	8 + 18	SPS 856 DD	17,821.00	8536
6 (63A)	8 + 18	SPS 856 DDA	19,461.00	8536
8 (40A)	8 + 24	SPS 857 DD	21,074.00	8536
8 (63A)	8 + 24	SPS 857 DDA	20,333.00	8536



PHASE SELECTOR CABINETS (3WAY+OFF)

40A	TPN	PSC 40	7889.00	8536
63A	TPN	PSC 63	10,005.00	8536



*Guaranteed for safety
and performance*

MINIATURE CIRCUIT BREAKER AND ISOLATORS

MADE IN INDIA

IS/IEC : 60898-1



CM/L : 9314573



CAT. No.	RATING / POLE	LIST PRICE	PACKAGING
SP			
MCB 10KA 'B' SERIES			
MCB 101	6A SP	245.00	12 Pcs.
MCB 101A	10A SP	245.00	12 Pcs.
MCB 101B	16A SP	245.00	12 Pcs.
MCB 101C	20A SP	245.00	12 Pcs.
MCB 101D	25A SP	245.00	12 Pcs.
MCB 101E	32A SP	245.00	12 Pcs.
MCB 102	40A SP	349.00	12 Pcs.
SP			
MCB 10KA 'C' SERIES			
MCB 103	6A SP	245.00	12 Pcs.
MCB 103A	10A SP	245.00	12 Pcs.
MCB 103B	16A SP	245.00	12 Pcs.
MCB 104	20A SP	245.00	12 Pcs.
MCB 104A	25A SP	245.00	12 Pcs.
MCB 104B	32A SP	245.00	12 Pcs.
MCB 105	40A SP	349.00	12 Pcs.
MCB 106	63A SP	552.00	12 Pcs.
SPN			
MCB 10KA 'C' SERIES			
MCB 107	6A SPN	811.00	06 Pcs.
MCB 107A	10A SPN	811.00	06 Pcs.
MCB 107B	16A SPN	811.00	06 Pcs.
MCB 108	20A SPN	811.00	06 Pcs.
MCB 108A	25A SPN	811.00	06 Pcs.
MCB 108B	32A SPN	811.00	06 Pcs.
MCB 109	40A SPN	1095.00	06 Pcs.
MCB 110	63A SPN	1188.00	06 Pcs.





DP			
MCB 111	6A DP	892.00	06 Pcs.
MCB 111A	10A DP	892.00	06 Pcs.
MCB 111B	16A DP	892.00	06 Pcs.
MCB 112	20A DP	892.00	06 Pcs.
MCB 112A	25A DP	892.00	06 Pcs.
MCB 112B	32A DP	892.00	06 Pcs.
MCB 113	40A DP	1151.00	06 Pcs.
MCB 114	63A DP	1321.00	06 Pcs.

TP			
MCB 115	6A TP	1311.00	04 Pcs.
MCB 115A	10A TP	1311.00	04 Pcs.
MCB 115B	16A TP	1311.00	04 Pcs.
MCB 116	20A TP	1311.00	04 Pcs.
MCB 116A	25A TP	1311.00	04 Pcs.
MCB 116B	32A TP	1311.00	04 Pcs.
MCB 117	40A TP	1808.00	04 Pcs.
MCB 118	63A TP	2062.00	04 Pcs.

TPN			
MCB 119	6A TPN	1682.00	03 Pcs.
MCB 119A	10A TPN	1682.00	03 Pcs.
MCB 119B	16A TPN	1682.00	03 Pcs.
MCB 120	20A TPN	1682.00	03 Pcs.
MCB 120A	25A TPN	1682.00	03 Pcs.
MCB 120B	32A TPN	1682.00	03 Pcs.
MCB 121	40A TPN	2308.00	03 Pcs.
MCB 122	63A TPN	2447.00	03 Pcs.

FP			
MCB 123	6A FP	1867.00	03 Pcs.
MCB 123A	10A FP	1867.00	03 Pcs.
MCB 123B	16A FP	1867.00	03 Pcs.
MCB 124	20A FP	1867.00	03 Pcs.
MCB 124A	25A FP	1867.00	03 Pcs.
MCB 124B	32A FP	1867.00	03 Pcs.
MCB 125	40A FP	2431.00	03 Pcs.
MCB 126	63A FP	2694.00	03 Pcs.

ISOLATOR			
ISR 201	40A SP	577.00	12 Pcs.
ISR 202	63A SP	738.00	12 Pcs.
ISR 203	40A DP	577.00	06 Pcs.
ISR 204	63A DP	738.00	06 Pcs.
ISR 209	100A DP	950.00	06 Pcs.
ISR 205	40A TP	858.00	04 Pcs.
ISR 206	63A TP	1055.00	04 Pcs.
ISR 206A	100A TP	1432.00	04 Pcs.
ISR 207	40A FP	1173.00	03 Pcs.
ISR 208	63A FP	1354.00	03 Pcs.
ISR 210	100A FP	2638.00	03 Pcs.

Salient Features :-

- Low watt. loss
- Finger touch
- Over Load Protection
- Trip free mechanism
- Liberal terminal design
- Short Circuit Protection



Electrical Excellence
Since 1935





- »» Automatic Changeover Switches
- »» Busbar Chambers
- »» Switch Fuse Units, Fuse Switch Units
- »» Changeover Switches
- »» Porcelain Fuse Units
- »» AC Boxes / Plug Socket with Enclosures
- »» Spares

Automatic Changeover Switches - DP, AND FP



Single Phase

Three Phase

Single Phase Change Over Switch :

Cat. No.	Rating Amp.	Type	Operating Voltage	M.R.P. / Pc.	Pack Qty.	HSN CODE
<i>New</i> AC-101	32A	DP	220 V AC +/- 10% 50 Hz	4194.00	10	8536
<i>New</i> AC-102	63A	DP	220 V AC +/- 10% 50 Hz	5136.00	08	8536

Three Phase Change Over Switch :

Cat. No.	Rating Amp.	Type	Operating Voltage	M.R.P. / Pc.	Pack Qty.	HSN CODE
<i>New</i> AC-108	63A	FP	220/415 V AC +/- 10% 50 Hz	9123.00	03	8536



Features of Automatic Gen / Main Changeover :

- ▶ Automatically changes the lines from Main to Gen Set & Vice Versa.
- ▶ Changing over the Main line with the relay.
- ▶ Auto Selector.
- ▶ Simplified and Easy Installation.
- ▶ Indication for active power source is available.
- ▶ Avoids physical operations and suffering.
- ▶ All comes as individual Compact Cubical unit.
- ▶ High grade heavy contact points.
- ▶ High quality powder coated CRC Cabinet.



SINGLE PHASE / THREE PHASE AUTOMATIC CHANGEOVER SWITCHES

Highly Reliable And Fully Guaranteed
For Performance

	RATING	TYPE	CAT. No.	LIST PRICE	HSN CODE
	16A 240V	SINGLE PHASE	ACS 786	3714.00	8536
	30A 240V	SINGLE PHASE	ACS 787	4166.00	8536
	60A 240V	SINGLE PHASE	ACS 788	6291.00	8536
	32A 415V	THREE PHASE	ACS 791	9686.00	8536
	63A 415V	THREE PHASE	ACS 792	15,269.00	8536



» BUSBAR CHAMBERS

TPN fitted with Silver Plated,
Electrolytic Copper

Highly Reliable And Fully Guaranteed
For Performance



Cat. No.	Amp.	Voltage	HSN Code	List Price
BUS-32A	32A	415V	8536	3071.00
BUS-63A	63A	415V	8536	4687.00
BUS-100A	100A	415V	8536	7308.00
BUS-200A	200A	415V	8536	11,460.00
BUS-320A	320A	415V	8536	16,564.00
BUS-400A	400A	415V	8536	23,059.00
BUS-600A	600A	415V	8536	33,545.00

What is Busbar chamber ?

Busbar Chambers are the metallic strips or bars, housed inside the switchgear, panel boards and busway enclosures for high current power distribution and ensure straightforward network configuration. The main purpose of using it to conduct a substantial current of electricity.

Why Busbar protection is required ?

The primary objective of busbar protection is to limit the damage to wires due to loose contacts and also to minimize power losses in distribution.

Switch Fuse Units,
Fuse Switch Units &
Change Over Switches

Change Over Switch
400A (Four Pole)
with special safety guard



Switch Fuse Units 100A



Fuse Switch Unit 400A (Four Pole)



Products Conforming to IS : 13947 Part I & 3 IE

RATING	TYPE	CAT. No.	LIST PRICE	HSN CODE	
	SWITCH FUSE UNIT (SINGLE POLE & NEUTRAL)				
	16A/240V	SPN	803	1104.00	8537
	32A/240V	SPN	807	2045.00	8537
	SWITCH FUSE UNIT (DOUBLE POLE)				
	16A/240V	DP	804	1304.00	8537
	32A/240V	DP	808	2217.00	8537
	63A/415V	DP	812	7659.00	8537
	SWITCH FUSE UNIT (TRIPLE POLE)				
	16A/415V	TP	805	2511.00	8537
	32A/415V	TP	810	3587.00	8537
	63A/415V	TP	813	9042.00	8537
	63A 415V	TP	813N	7349.00	8537
	100A/415V	TP	816	19,958.00	8537
	SWITCH FUSE UNIT (TRIPLE POLE & NEUTRAL)				
	16A/415V	TPN	806	2587.00	8537
	32A/415V	TPN	811	3645.00	8537
	63A/415V	TPN	814	9084.00	8537
	100A/415V	TPN	815	20,528.00	8537
	FUSE SWITCH UNIT (TRIPLE POLE & NEUTRAL - WITH HRC FUSES)				
	200A/415V	TPN	820H	24,926.00	8537
	320A/415V	TPN	821H	32,910.00	8537
	400A/415V	TPN	822H	50,531.00	8537
	FUSE SWITCH UNIT (FOUR POLE - WITH HRC FUSES)				
	200A/415V	FP	817H	31,945.00	8537
	320A/415V	FP	818H	38,356.00	8537
	400A/415V	FP	819H	68,240.00	8537
	FUSE SWITCH UNIT (TRIPLE POLE & NEUTRAL - WITHOUT HRC FUSES)				
	200A/415V	TPN	820	21,429.00	8537
	320A/415V	TPN	821	26,381.00	8537
	400A/415V	TPN	822	35,264.00	8537
	FUSE SWITCH UNIT (FOUR POLE - WITHOUT HRC FUSES)				
	200A/415V	FP	817	28,341.00	8537
	320A/415V	FP	818	32,890.00	8537
	400A/415V	FP	819	54,723.00	8537



RATING	TYPE	CAT. No.	LIST PRICE	HSN CODE
--------	------	----------	------------	----------

CHANGE OVER SWITCH (FOUR POLE)

16A/415V	FP	825	4225.00	8536
32A/415V	FP	826	4845.00	8536
63A/415V	FP	829	10,561.00	8536
63A/415V	FP WITH PORCELAIN	829P	10,561.00	8536
100A/415V	FP	830N	21,112.00	8536
200A/415V	FP	831	28,327.00	8536
300A/415V	FP	832	34,909.00	8536
400A/415V	FP	833	48,528.00	8536

CHANGE OVER SWITCH (DOUBLE POLE)

16A/240V	DP	827	1218.00	8536
32A/240V	DP	828	2658.00	8536
63A/415V	DP	829N	5692.00	8536



PORCELAIN FUSE UNITS

16A 240V	SINGLE POLE	898	128.00	8536
16A 415V	SINGLE POLE	899	187.00	8536
32A 415V	SINGLE POLE	800	358.00	8536
63A 415V	SINGLE POLE	896	1070.00	8536
63A 415V	SINGLE POLE	896N	954.00	8536
100A 415V	SINGLE POLE	897	1739.00	8536
100A 415V	SINGLE POLE	897N	1393.00	8536



16A 240V

32A 415V



63A 415V

100A 415V

PORCELAIN FUSE UNITS WITH EXTENSION STRIPS

63A 415V	SINGLE POLE	893	1087.00	8536
100A 415V	SINGLE POLE	894	1557.00	8536
200A 415V	SINGLE POLE	789	3100.00	8536



63A 415V

100A 415V

200A 415V

NEUTRAL LINKS WITH PORCELAIN BASE

16A	SPARE	101	70.00	8536
32A	SPARE	102	112.00	8536
63A	SPARE	103A	186.00	8536
100A	SPARE	104A	601.00	8536



THE MOST RELIABLE RANGE OF SWITCHGEAR & CHANGE OVER SWITCHES.

- 1) Products conforming to IS : 13947 part 1 & 3 IEC : 60947 part 1 & 2.
- 2) Quick make & break mechanism independent of speed of operating handle.
- 3) Heavy duty spring loaded ETP copper contacts provided for low watt losses & energy saving thus reducing operational cost.
- 4) Flip type spring loaded male contacts / blades provided for splitting and quenching of arc during break operation in high rating change over switches.
- 5) Transparent polycarbonate shroud provided for protection of operator and direct visibility of contacts in high rating changeover switches.
- 6) Additional safety guard has been provided at the incoming side to prevent accident touch with live contacts at the time of maintenance in double break fuse switches.
- 7) State of the Art 8=tank technology employed for anti-rust pretreatment & phosphating.

	RATING	TYPE	CAT. No.	LIST PRICE	HSN CODE
	PLUG SOCKET WITH ENCLOSURES (CIRCUIT BREAKER CONTROLLED)				
	20A SPN	WITH STARTER	834	1799.00	8536
	10A SPN	WITH SP MCB	835AM	1645.00	8536
	20A SPN	WITH SP MCB	835M	1705.00	8536
	10A DP	WITH DP MCB	836AM	2405.00	8536
	20A DP	WITH DP MCB	836M	2762.00	8536
	20A TPN	WITH TP MCB	878AM	3928.00	8536
	32A TPN	WITH TP MCB	878M	4158.00	8536
	PLUG SOCKET WITH ENCLOSURES (CIRCUIT BREAKER CONTROLLED)				
	10A SPN	WITHOUT MCB	835A	1343.00	8536
	20A SPN	WITHOUT MCB	835	1447.00	8536
	10A DP	WITHOUT MCB	836A	1343.00	8536
	20A DP	WITHOUT MCB	836	1466.00	8536
	20A TPN	WITHOUT MCB	878A	2341.00	8536
	32A TPN	WITHOUT MCB	878	2894.00	8536
	PLUG & SOCKETS				
	10A SPN	PLUG	P 875	319.00	8537
	20A SPN	PLUG	P 876	385.00	8537
	20A TP	PLUG	P 878	782.00	8537
	30A TP	PLUG	P 879	1181.00	8537
	10A SPN	SOCKET	S 875	337.00	8537
	20A SPN	SOCKET	S 876	413.00	8537
	20A TP	SOCKET	S 878	852.00	8537
	30A TP	SOCKET	S 879	1217.00	8537

COVER MOUNTED ADVANTAGE

- 1) TOTAL HUMAN SAFETY ensure while plugging so that "Earth Connection" is made first before the "Phase Connection". Dring disconnecting "Earth Contact" breaks after the "Phase Contact" i.e. EARTH FIRST MAKE, LAST BREAK.
- 2) Socket unit specially COVER MOUNTED to keep it separate during construction activity.
- 3) Artistically deep drawn enclosure avoiding wild joints for better aesthetics and strength.
- 4) Easy and quick fitting / connections ensured by pre-wired unit with adopter.
- 5) Suitable for short circuit & overload protection of Ac's / Geysers etc. When fitted with MCB.

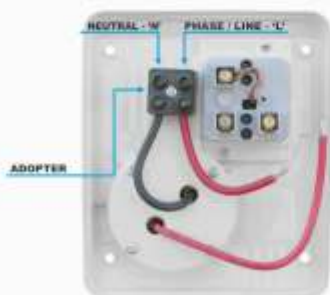

FRONT COVER



BACK BASE

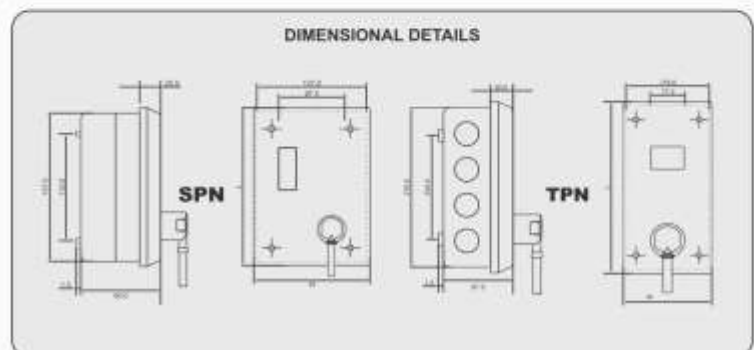



RATING







TYPE

CAT. No.





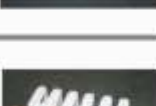

LIST PRICE

HSN CODE

FUSE SWITCH UNIT - DOUBLE BREAK



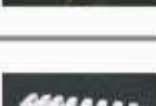







ACTION ROD THREE POLE (FITTED)		200A / 415V	ACTION ROD THREE POLE (FITTED)	820002	5514.00	8538
		200A / 415V	ACTION ROD FOUR POLE (FITTED)	817008	7651.00	8538
ACTION ROD FOUR POLE (FITTED)		200A / 415V	ACTION ROD BAKELITE STRIP BIG (THREE POLE)	817007	426.00	8538
		200A / 415V	ACTION ROD BAKELITE STRIP SMALL (THREE POLE)	817006	393.00	8538
ACTION ROD BAKELITE STRIP BIG (THREE POLE)		320A / 415V	ACTION ROD THREE POLE (FITTED)	821002	6766.00	8538
		320A / 415V	ACTION ROD FOUR POLE (FITTED)	818003	8260.00	8538
ACTION ROD BAKELITE STRIP SMALL (THREE POLE)		320A / 415V	ACTION ROD BAKELITE STRIP BIG (THREE POLE)	817007	426.00	8538
		320A / 415V	ACTION ROD BAKELITE STRIP SMALL (THREE POLE)	817006	393.00	8538
ACTION ROD BAKELITE STRIP BIG (THREE POLE)		400A / 415V	ACTION ROD THREE POLE (FITTED)	822003	7217.00	8538
		400A / 415V	ACTION ROD FOUR POLE (FITTED)	819003	8900.00	8538
ACTION ROD BAKELITE STRIP SMALL (THREE POLE)		400A / 415V	ACTION ROD BAKELITE STRIP BIG (THREE POLE)	817007	426.00	8538
		400A / 415V	ACTION ROD BAKELITE STRIP SMALL (THREE POLE)	817006	393.00	8538

FUSE SWITCH UNIT - DOUBLE BREAK

BASE BAKELITE STRIP THREE POLE (FITTED)		200A / 415V	BASE BAKELITE STRIP THREE POLE (FITTED)	820001	3804.00	8538
		200A / 415V	BASE BAKELITE STRIP THREE POLE	817004	393.00	8538
BASE BAKELITE STRIP THREE POLE		200A / 415V	HANDLE KNOB	815007	66.00	8538
		200A / 415V	DMC BASE SET (ASSEMBLY)	817099	1135.00	8538
HANDLE KNOB		320A / 415V	BASE BAKELITE STRIP THREE POLE (FITTED)	821001	5705.00	8538
		320A / 415V	BASE BAKELITE STRIP THREE POLE	817004	393.00	8538
DMC BASE SET (ASSEMBLY)		320A / 415V	HANDLE KNOB	815007	66.00	8538
		320A / 415V	DMC BASE SET (ASSEMBLY)	818001	1483.00	8538
BASE BAKELITE STRIP THREE POLE (FITTED)		400A / 415V	BASE BAKELITE STRIP THREE POLE (FITTED)	822001	6131.00	8538
		400A / 415V	BASE BAKELITE STRIP THREE POLE	817004	393.00	8538
HANDLE KNOB		400A / 415V	HANDLE KNOB	815007	66.00	8538
		400A / 415V	DMC BASE SET (ASSEMBLY)	819001	1909.00	8538

FUSE SWITCH UNIT - DOUBLE BREAK

BASE BAKELITE STRIP FOUR POLE (FITTED)		200A / 415V	BASE BAKELITE STRIP FOUR POLE (FITTED)	817005	4947.00	8538
		200A / 415V	BASE BAKELITE STRIP FOUR POLE	817004	393.00	8538
		200A / 415V	DMC BASE	817001	218.00	8538
		200A / 415V	DMC COVER	817002	72.00	8538

	No. OF WAYS	TYPE	CAT. No.	LIST PRICE	HSN CODE	
FUSE SWITCH UNIT - DOUBLE BREAK						
BASE BAKELITE STRIP (FOUR POLE)		320A / 415V	BASE BAKELITE STRIP FOUR POLE (FITTED)	818002	6342.00	8538
		320A / 415V	BASE BAKELITE STRIP FOUR POLE	817004	393.00	8538
		320A / 415V	DMC BASE	817001	218.00	8538
DMC BASE		320A / 415V	DMC COVER	817002	72.00	8538
		400A / 415V	BASE BAKELITE STRIP FOUR POLE (FITTED)	819002	8054.00	8538
DMC COVER		400A / 415V	BASE BAKELITE STRIP FOUR POLE	817004	393.00	8538
		400A / 415V	DMC BASE	817001	218.00	8538
		400A / 415V	DMC COVER	817002	72.00	8538
FUSE SWITCH UNIT - DOUBLE BREAK						
ACTION ROD BAKELITE STRIP BIG (FOUR POLE)		200A / 415V	ACTION ROD BAKELITE STRIP BIG (FOUR POLE)	817007	426.00	8538
		200A / 415V	ACTION ROD BAKELITE STRIP SMALL (FOUR POLE)	817006	393.00	8538
		200A / 415V	NEUTRAL LINK COMPLETE	820008	930.00	8538
ACTION ROD BAKELITE STRIP SMALL (FOUR POLE)		200A / 415V	HANDLE ROD COMPLETE	820010	559.00	8538
		320A / 415V	ACTION ROD BAKELITE STRIP BIG (FOUR POLE)	817007	426.00	8538
NEUTRAL LINK COMPLETE		320A / 415V	ACTION ROD BAKELITE STRIP SMALL (FOUR POLE)	817006	393.00	8538
		320A / 415V	NEUTRAL LINK COMPLETE	821008	829.00	8538
		320A / 415V	HANDLE ROD COMPLETE	820010	559.00	8538
HANDLE ROD COMPLETE		400A / 415V	ACTION ROD BAKELITE STRIP BIG (FOUR POLE)	817007	426.00	8538
		400A / 415V	ACTION ROD BAKELITE STRIP SMALL (FOUR POLE)	817006	393.00	8538
		400A / 415V	NEUTRAL LINK COMPLETE	822008	930.00	8538
	400A / 415V	HANDLE ROD COMPLETE	820010	559.00	8538	
SPARE FOR REWIREABLE SWITCH FUSE						
PORCELAIN FUSE FITTED BASE		16A / 240V	PORCELAIN FUSE FITTED BASE	803001	66.00	8538
		16A / 240V	PORCELAIN FUSE FITTED CARRIER	803002	87.00	8538
		16A / 240V	END SHIELD ASSEMBLY	803003	166.00	8538
		16A / 240V	BAKELITE KNOB	803006	21.00	8538
PORCELAIN FUSE FITTED CARRIER		32A / 240V & 16A / 415V	PORCELAIN FUSE FITTED BASE	805001	149.00	8538
		32A / 240V & 16A / 415V	PORCELAIN FUSE FITTED CARRIER	805002	174.00	8538
		32A / 240V & 16A / 415V	END SHIELD ASSEMBLY	805003	110.00	8538
		32A / 240V & 16A / 415V	BAKELITE KNOB	803006	21.00	8538
		32A / 415V	PORCELAIN FUSE FITTED BASE	810001	210.00	8538
		32A / 415V	PORCELAIN FUSE FITTED CARRIER	810002	274.00	8538
END SHIELD ASSEMBLY		32A / 415V	END SHIELD ASSEMBLY	810003	154.00	8538
		32A / 415V	BAKELITE KNOB	810007	25.00	8538
		63A / 415V	PORCELAIN FUSE FITTED BASE	813001	586.00	8538
		63A / 415V	PORCELAIN FUSE FITTED CARRIER	813002	862.00	8538
BAKELITE KNOB		63A / 415V	END SHIELD ASSEMBLY	813003	402.00	8538
		63A / 415V	BAKELITE KNOB	813008	47.00	8538
		100A / 415V	PORCELAIN FUSE FITTED BASE	815001	963.00	8538
		100A / 415V	PORCELAIN FUSE FITTED CARRIER	815002	1227.00	8538
		100A / 415V	END SHIELD ASSEMBLY	815003	1729.00	8538
	100A / 415V	BAKELITE KNOB	815007	66.00	8538	

	No. OF WAYS	TYPE	CAT. No.	LIST PRICE	HSN CODE	
SPARE FOR REWIREABLE SWITCH FUSE						
BAKELITE TUBE		16A / 240V	BAKELITE TUBE	803010	32.00	8538
		16A / 240V	END SHIELD BASE / COVER PORC. / DMC	803003	166.00	8538
		16A / 240V	ACTION ROD FITTED	803004	166.00	8538
		16A / 240V	ACTION U	803005	44.00	8538
		32A / 240V	BAKELITE TUBE	808010	42.00	8538
END SHIELD BASE / COVER PORCELAIN / DMC		32A / 240V	END SHIELD BASE / COVER PORC. / DMC	805004	68.00	8538
		32A / 240V	ACTION ROD FITTED	807001	205.00	8538
		32A / 240V	ACTION U	805006	50.00	8538
		16A / 415V	BAKELITE TUBE	805010	47.00	8538
		16A / 415V	END SHIELD BASE / COVER PORC. / DMC	805004	68.00	8538
ACTION ROD FITTED		16A / 415V	ACTION ROD FITTED	805005	274.00	8538
		16A / 415V	ACTION U	805006	50.00	8538
		32A / 415V	BAKELITE TUBE	810010	68.00	8538
		32A / 415V	END SHIELD BASE / COVER PORC. / DMC	810004	77.00	8538
		32A / 415V	ACTION ROD FITTED	810005	447.00	8538
ACTION U		32A / 415V	ACTION U	810006	89.00	8538
		63A / 415V	BAKELITE TUBE	813009	149.00	8538
		63A / 415V	END SHIELD BASE / COVER PORC. / DMC	813005	134.00	8538
		63A / 415V	ACTION ROD FITTED	813006	971.00	8538
		63A / 415V	ACTION U	813007	198.00	8538
		100A / 415V	BAKELITE TUBE	815008	210.00	8538
		100A / 415V	END SHIELD BASE / COVER PORC. / DMC	815004	271.00	8538
		100A / 415V	ACTION ROD FITTED	815005	2474.00	8538
		100A / 415V	ACTION U	815006	547.00	8538
SPARES FOR CHANGEOVER SWITCH						
DMC BASE ASSEMBLY		16A / 240V DP	DMC BASE ASSEMBLY	827001	422.00	8538
		16A / 240V DP	DMC BASE AND COVER	825001	248.00	8538
DMC BASE AND COVER		16A / 240V DP	ACTION ROD (ASSEMBLY)	827003	277.00	8538
		16A / 240V DP	ACTION ROD WITH TUBE	827011	156.00	8538
ACTION ROD (ASSEMBLY)		32A / 240V DP	DMC BASE ASSEMBLY	828001	634.00	8538
		32A / 240V DP	DMC BASE AND COVER	826001	274.00	8538
ACTION ROD WITH TUBE		32A / 240V DP	ACTION ROD (ASSEMBLY)	828002	564.00	8538
		32A / 240V DP	ACTION ROD WITH TUBE	828011	178.00	8538
		63A / 415V DP	DMC BASE ASSEMBLY	829001	447.00	8538
		63A / 415V DP	DMC BASE AND COVER	813005	134.00	8538
		63A / 415V DP	ACTION ROD (ASSEMBLY)	829012	1078.00	8538
		63A / 415V DP	ACTION ROD WITH TUBE	829009	248.00	8538
SPARES FOR CHANGEOVER SWITCH						
ACTION U		16A / 240V DP	ACTION U	827002	50.00	8538
		16A / 240V DP	HANDLE KNOB	803006	21.00	8538
HANDLE KNOB		16A / 240V DP	BAKELITE TUBE	827010	32.00	8538
		16A / 240V DP	HANDLE ROD COMPLETE	827012	68.00	8538
BAKELITE TUBE		32A / 240V DP	ACTION U	826003	76.00	8538
		32A / 240V DP	HANDLE KNOB	817007	426.00	8538
		32A / 240V DP	BAKELITE TUBE	828010	42.00	8538
		32A / 240V DP	HANDLE ROD COMPLETE	827012	68.00	8538

	No. OF WAYS	TYPE	CAT. No.	LIST PRICE	HSN CODE	
SPARES FOR CHANGEOVER SWITCH						
HANDLE ROD COMPLETE		63A / 415V DP	ACTION U	813007	198.00	8538
		63A / 415V DP	HANDLE KNOB	813008	47.00	8538
		63A / 415V DP	BAKELITE TUBE	829010	55.00	8538
		63A / 415V DP	HANDLE ROD COMPLETE	829013	211.00	8538
SPARES FOR CHANGEOVER SWITCH						
DMC BASE ASSEMBLY		16A / 415V FP	DMC BASE ASSEMBLY	825002	582.00	8538
		16A / 415V FP	DMC BASE AND COVER	825001	248.00	8538
		16A / 415V FP	ACTION ROD ASSEMBLY	825004	582.00	8538
DMC BASE AND COVER		16A / 415V FP	ACTION ROD WITH TUBE	825011	201.00	8538
		32A / 415V FP	DMC BASE ASSEMBLY	826002	634.00	8538
ACTION ROD (ASSEMBLY)		32A / 415V FP	DMC BASE AND COVER	826001	274.00	8538
		32A / 415V FP	ACTION ROD ASSEMBLY	826004	634.00	8538
ACTION ROD WITH TUBE		32A / 415V FP	ACTION ROD WITH TUBE	826011	238.00	8538
		63A / 415V FP	DMC BASE ASSEMBLY	829001	447.00	8538
		63A / 415V FP	DMC BASE AND COVER	813005	134.00	8538
		63A / 415V FP	ACTION ROD ASSEMBLY	829002	2110.00	8538
		63A / 415V FP	ACTION ROD WITH TUBE	829011	503.00	8538
SPARES FOR CHANGEOVER SWITCH						
ACTION U		16A / 415V FP	ACTION U	825003	65.00	8538
		16A / 415V FP	HANDLE KNOB	810007	25.00	8538
		16A / 415V FP	BAKELITE TUBE	825010	44.00	8538
HANDLE KNOB		16A / 415V FP	BAKELITE ASSEMBLY WITHOUT KNIFE	830004 (100A)	2741.00	8538
		32A / 415V FP	ACTION U	826003	76.00	8538
BAKELITE TUBE		32A / 415V FP	HANDLE KNOB	810007	25.00	8538
		32A / 415V FP	BAKELITE TUBE	826010	50.00	8538
		32A / 415V FP	BAKELITE ASSEMBLY WITHOUT KNIFE	831004 (200A)	4037.00	8538
		63A / 415V FP	ACTION U	813007	198.00	8538
BAKELITE ASSEMBLY WITHOUT KNIFE		63A / 415V FP	HANDLE KNOB	813008	47.00	8538
		63A / 415V FP	BAKELITE TUBE	829014	189.00	8538
		63A / 415V FP	BAKELITE ASSEMBLY WITHOUT KNIFE	833004 (400A)	5607.00	8538
SPARES FOR CHANGEOVER SWITCH						
BASE BAKELITE STRIP (ASSEMBLY)		100A / 415V	BASE BAKELITE STRIP (ASSEMBLY)	830003	11,316.00	8538
		100A / 415V	BASE BAKELITE STRIP	830001	337.00	8538
		100A / 415V	BAKELITE STRIP TOP (BAKELITE)	830002	389.00	8538
		100A / 415V	MOVING CONTACT	830006	2521.00	8538
BASE BAKELITE STRIP		200A / 415V	BASE BAKELITE STRIP (ASSEMBLY)	831003	7490.00	8538
		200A / 415V	BASE BAKELITE STRIP	831001	389.00	8538
		200A / 415V	BAKELITE STRIP TOP (BAKELITE)	831002	451.00	8538
		200A / 415V	MOVING CONTACT	831006	3053.00	8538
BAKELITE STRIP TOP (BAKELITE)		320A / 415V	BASE BAKELITE STRIP (ASSEMBLY)	832003	9500.00	8538
		320A / 415V	BASE BAKELITE STRIP	832001	413.00	8538
		320A / 415V	BAKELITE STRIP TOP (BAKELITE)	832002	493.00	8538
MOVING CONTACT		320A / 415V	MOVING CONTACT	832006	3372.00	8538
		400A / 415V	BASE BAKELITE STRIP (ASSEMBLY)	833003	11,316.00	8538
		400A / 415V	BASE BAKELITE STRIP	833001	451.00	8538
		400A / 415V	BAKELITE STRIP TOP (BAKELITE)	833002	526.00	8538
		400A / 415V	MOVING CONTACT	833006	3688.00	8538

*Add a touch of
Sophistication*

THE
HERITAGE
COLLECTION



24kt Gold Plated



Antique Brass



Antique Copper



Brushed Brass



Rose Gold



Matt Black



Matt Black



24kt Gold Plated



Brushed Brass



Antique Copper



Antique Brass



Old Brass

Hotels :

- | | |
|-----------------------------|--|
| 1. Le Meridien, Delhi | 11. Malabar Palace, Calicut |
| 2. Le Meridian, Jaipur | 12. Hotel Leela Venture, Bangalore |
| 3. Taj Hari, Jodhpur | 13. Shiv Vilas Palace, Jaipur |
| 4. Hyatt Regency, Goa | 14. Goan Heritage Beach Resort, Goa |
| 5. Hotel Fidalgo, Goa | 15. Hotel Raddison, Gurgaon |
| 6. Marine Plaza, Mumbai | 16. Lemon Tree Hotel, Pune |
| 7. Hotel Arora Towers, Pune | 17. Lemon Tree Hotel, Gaziabad |
| 8. Krishna Residency, Pune | 18. Gateway Hotels (Taj Group). Varanasi |
| 9. Intercontinental, Mumbai | 19. Ginger Hotel, Guwahati |
| 10. Renaissance Hotel, Goa | 20. Tea Trails Pvt. Ltd. Sri Lanka |



Le Meridien-Delhi



Hotel Ginger-Guwahati



Le Meridien- Jodhpur



Marine Plaza-Mumbai



Hotel Radisson-Gurgaon



Fortis Hospital-Amritsar

Housing / Commercial Projects :

- | | |
|------------------------------------|----------------------------------|
| 1. DIF | 11. Akashganga, Jaipur |
| 2. Unitech | 12. Brahma Majestic, Pune |
| 3. Essel Tower, Gurgaon | 13. Nike Nore & Associates, Pune |
| 4. Raheja Builders | 14. Sanghvi Builders pune |
| 5. Niho | 15. Eaha Realators, Pune |
| 6. Eldeco | 16. Landscape Construction, Goa |
| 7. Parshnath | 17. Ansal City, Jodhpur |
| 8. Hewo | 18. Cottan City, Coimbatore |
| 9. Awho | 19. Index One, Jaipur |
| 10. Ansel | 20. Parmar Builder, Pune |
| 11. Shapoorji Pallonji Group, Pune | |

Hospitals :

- | | |
|---------------------------------|----------------------------------|
| 1. Escorts, Amritsar | 5. Sir Ganga Ram Hospital, Delhi |
| 2. Apollo, Delhi | 6. Batra Hospital, Delhi |
| 3. DMC, Ludhiana | 7. Forts, Mohali |
| 4. Vintage Hospital, Panjim Goa | 8. AIIMS, Rishikesh and Hojhpur |

Government / Public Sector / Private Sector / Others :

- | | |
|---|------------------------------------|
| 1. Parliament House | 16. Rail Coach Factory, Kapurthala |
| 2. THDC | 17. NTPC |
| 3. PSEB | 18. MPEB |
| 4. Chattisgarh Electricity Board | 19. LIC of India |
| 5. United Bank of India | 20. ICICI Bank |
| 6. PWD, Punjab, Haryana, Rajasthan | 21. BHEL |
| 7. AECL | 22. HCL |
| 8. ITI Rai Bareilly | 23. GNVF Ltd. |
| 9. HAL | 24. BEL |
| 10. CPWD | 25. NFL |
| 11. UTI Bank | 26. IOCL |
| 12. Kalpataru Power Transmission Ltd. | 27. Biocon, Bangalore |
| 13. National Institute of Oceanography, Goa | 28. Krishi Bhawan, Goa |
| 14. GSIDC, Panjim, Goa | 29. Ordnance Factory, Khamaria |
| 15. Airport Authority of India | 30. SBI and many mores... |



Apollo Hospital-Delhi



Parmar Builders-Pune



Airport Authority of India

warranty



Warranty Policy :-

- All switches and sockets carry a warranty of 10 years from the date of purchase except L.E.D. indicators, Regulators, AC Starters and Electronic Items.
- L.E.D. Indicators Regulators, AC Starters and Electronic Items carry a warranty of 2 years from the date of purchase.
- The warranty is applicable only against manufacturing defects or faulty workmanship.
- The warranty is however subject to the provision of proper usage and does not cover surface coated products, normal wear and tear of parts, defects arising out of fire, accident, voltage fluctuations and willful or accidental damage.
- The manufacturer will not be liable for any consequential loss, injury or damages attributable to defect or failure of its products.
- The company reserves the right to change/improve the design, without prior notice. In such cases, replacements shall be carried out with the design prevailing at that point in time.



Terms and Conditions :-

- Prices are in Indian Rupees.
- This price list supersedes all previous price lists.
- Prices are subject to change without prior notice.
- Dispute if any are subject to Kapurthala jurisdiction only.



Warranty Policy :-

- All switches and sockets carry a warranty of 10 years from the date of purchase except L.E.D. indicators, Regulators, AC Starters and Electronic Items.
- L.E.D. Indicators Regulators, AC Starters and Electronic Items carry a warranty of 2 years from the date of purchase.
- The warranty does not cover metal wall boxes.
- The warranty is applicable only against manufacturing defects or faulty workmanship.
- The warranty is however subject to the provision of proper usage and does not cover surface coated products, normal wear and tear of parts, defects arising out of fire, accident, voltage fluctuations and willful or accidental damage.
- The manufacturer will not be liable for any consequential loss, injury or damages attributable to defect or failure of its products.
- The company reserves the right to change/improve the design, without prior notice. In such cases, replacements shall be carried out with the design prevailing at that point in time.